



Broj: 02/1-1068/1

Datum: 01.09.2020.

**UNIVERZITET CRNE GORE**

**- Centru za doktorske studije -**

**- Senatu -**

**O V D J E**

U prilogu dostavljamo Odluku Vijeća Elektrotehničkog fakulteta sa sjednice od 24.07.2020. godine i obrazac **D2**, sa pratećom dokumentacijom, za kandidata mr **Avnija Alidemaja**, na dalji postupak.

**DEKAN,**



**Prof. dr Saša Mujović**



## ISPUNJENOST USLOVA DOKTORANDA

OPŠTI PODACI O DOKTORANDU			
Titula, ime, ime roditelja, prezime	Mr Avni Sali Alidemaj		
Fakultet	Elektrotehnički fakultet		
Studijski program	Doktorske studije elektrotehnike		
Broj indeksa	6/12		
NAZIV DOKTORSKE DISERTACIJE			
Na službenom jeziku	Uticaj karakteristika visokonaponskih prekidača sa gasom SF <sub>6</sub> na proces isključenja iz mreže generatora velike snage		
Na engleskom jeziku	Influence of characteristics of high voltage circuit breakers with SF <sub>6</sub> gas on disconnection of large generators from network		
Naučna oblast	Elektroenergetski sistemi		
MENTOR/MENTORI			
Prvi mentor	Prof. dr Sreten Škuletić	Elektrotehnički fakultet, Univerzitet Crne Gore, Crna Gora	Elektroenergetski sistemi
Drugi mentor			
KOMISIJA ZA PREGLED I OCJENU DOKTORSKE DISERTACIJE			
Prof. dr Vladan Radulović		Elektrotehnički fakultet, Univerzitet Crne Gore, Crna Gora	Elektroenergetski sistemi
Prof. dr Sreten Škuletić		Elektrotehnički fakultet, Univerzitet Crne Gore, Crna Gora	Elektroenergetski sistemi
Akademik dr Isuf Krasniqi		Elektrotehnički fakultet i fakultet kompjuterstva, Univerzitet u Prištini	Elektroenergetski sistemi
Datum značajni za ocjenu doktorske disertacije			
Sjednica Senata na kojoj je data saglasnost na ocjenu teme i kandidata	28.11.2013 god.		
Dostavljanja doktorske disertacije organizacionoj jedinici i saglasnost mentora	21.07.2020 god.		
Sjednica Vijeća organizacione jedinice na kojoj je dat prijedlog za imenovanje komisija za pregled i ocjenu	24.07.2020 god.		



doktorske disertacije	
<b>ISPUNJENOST USLOVA DOKTORANDA</b>	
U skladu sa članom 38 pravila doktorskih studija kandidat <b>je</b> cjelokupna ili dio sopstvenih istraživanja vezanih za doktorsku disertaciju publikovao u časopisu sa <b>SCIE</b> liste kao prvi autor.	
<b>Spisak radova doktoranda iz oblasti doktorskih studija koje je publikovao u časopisima sa (upisati odgovarajuću listu)</b>	
Avni Alidemaj, Qendrim Nika: „Important Factors for Consideration during the Specification of SF6 Circuit Breakers for High Voltage Generators“, Energies 2020, 13(14), 3608; <a href="https://doi.org/10.3390/en13143608">https://doi.org/10.3390/en13143608</a>	
<b>Obrazloženje mentora o korišćenju doktorske disertacije u publikovanim radovima</b>	
U objavljenom radu su korišćeni rezultati istraživanja datih u doktorskoj disertaciji vezanih za različite uglove sinhronog generatora pri nesinhronizovanom uključanju na mrežu. Razmatrane su posljedice u pogledu porasta struje i uticaj ovih situacija na reagovanje prekidača sa SF6 gasom i mogućnost prekidanja struje kvara.	
<b>Datum i ovjera (pečat i potpis odgovorne osobe)</b>	
U Podgorici, 24.07.2020 god.	  DEKAN

**Prilog dokumenta sadrži:**

1. Potvrdu o predaji doktorske disertacije organizacionoj jedinici
2. Odluku o imenovanju komisije za pregled i ocjenu doktorske disertacije
3. Kopiju rada publikovanog u časopisu sa odgovarajuće liste
4. Biografiju i bibliografiju kandidata
5. Biografiju i bibliografiju članova komisije za pregled i ocjenu doktorske disertacije sa potvrdom o izboru u odgovarajuće akademsko zvanje i potvrdom da barem jedan član komisije nije u radnom odnosu na Univerzitetu Crne Gore



Univerzitet Crne Gore

Univerzitet Crne Gore  
**ELEKTROTEHNIČKI FAKULTET**

81000 Podgorica, Dž. Vašingtona bb, tel. (020) 245 839, fax: (020) 245 873  
Ž.R. 510-255-51, PIB: 02016702 302, PDV: 30/31-03951-6



Broj: 02/1-1022/2  
Datum: 22.07.2020

Na osnovu službene evidencije i dokumentacije Elektrotehničkog fakulteta u Podgorici, izdaje se

**P O T V R D A**

Mr **Avni Alidemaj**, student doktorskih studija na Elektrotehničkom fakultetu u Podgorici, dana 21.07.2020. godine dostavio je ovom Fakultetu doktorsku disertaciju pod nazivom: „**Uticaj karakteristika visokonaponskih prekidača sa gasom SF6 na proces isključenja iz mreže generatora velike snage**“, na dalji postupak.



**DEKAN,**

**Prof. dr Saša Mujović**







Broj: 02/1-1068

Datum: 24.07.2020.

Na osnovu člana 64 Statuta Univerziteta Crne Gore, u vezi sa članom 55 Pravila doktorskih studija, na predlog Komisije za doktorske studije, Vijeće Elektrotehničkog fakulteta u Podgorici, na sjednici od 24.07.2020. godine, donijelo je

### **O D L U K U**

**I** Utvrđuje se da su ispunjeni uslovi iz Pravila doktorskih studija za dalji rad na doktorskoj disertaciji „**Uticaj karakteristika visokonaponskih prekidača sa gasom SF6 na proces isključenja iz mreže generatora velike snage**“ kandidata mr **Avnija Alidemaja**.

**II** Predlaže se **Komisija za ocjenu navedene doktorske disertacije, u sastavu:**

1. Dr Vladan Radulović, vanredni profesor Elektrotehničkog fakulteta Univerziteta Crne Gore,
2. Dr Sreten Škuletić, redovni profesor Elektrotehničkog fakulteta Univerziteta Crne Gore,
3. Akademik dr Isuf Krasniqi, redovni profesor Elektrotehničkog fakulteta i fakulteta kompjuterstva Univerziteta u Prištini.

Komisija iz tačke II ove Odluke podnijeće Izvještaj Vijeću Fakulteta u roku od 45 dana od dana imenovanja.

**-VIJEĆE ELEKTROTEHNIČKOG FAKULTETA-**

**DEKAN,**

**Prof. dr Saša Mujović**



Dostavljeno:

- Senatu,
- Centru za doktorske studije,
- u dosije,
- a/a.



## Spisak radova sa rezultatima iz doktorske teze

### Avni Alidemaj

<b>Osnovni podaci</b>	
Rođendan, mjesto i općina.	16.10.1967, S. Kernina, Istog, Kosovo
Pol.	M
Adresa	Ul. Zhujë Selmani, B.B, Peć, Kosovo
Građanski status.	Oženjen, troje djece.
<b>Obrazovanje i akademska zvanja</b>	
<b>2013</b>	Registracija Doktorata u Univerzitetu Crne Gore, Elektrotehnički Fakultet, Podgorica.
	<b>Teza:</b> "Uticaj karakteristika visokonaponskih prekidača sa gasom SF <sub>6</sub> na proces isključenja iz mreže generatora velike snage"
<b>2008</b>	Mr. Sc., Univerzitet u Prištini, Fakultet elektrotehnike i računarske tehnike.
	<b>Teza:</b> "Uticaj korone na vrednost energestkih gubitaka na prenosne mreže 220 kV i 400 kV kao i njen efekat na širenje radio i TV talasa"
<b>1997</b>	Diplomirani inženjer elektrotehnike, Univerzitet u Prištini, Tehnički Fakultet
	<b>Teza:</b> "Negativni i pozitivni efekti fenomena korone u tehnici visokog napona"
<b>Profesionalna karijera</b>	
2010-2015	Asistent, Univerzitet u Prištini, Fakultet elektrotehnike i računarske tehnike.
Decembar 2019-U toku	Vanredni profesor, Sveučilište Obrazovanje za poslovno-tehnološka (UBT), Priština.
14 Mart 2019 U toku	Izvršni savjetnik, KEDS
27 Mart 2017 - 14 Marta 2019	Direktor za saradnju sa vladinim institucijama i kontrolu investicija, KEDS
Mart 2014-27 Marta 2017	Direktor za Operacije i Održavanje Mreže, KEDS
Januar 2013 - Maj 2013	V.D. Generalni Direktor, KEDS_a
Juni 2008 - Mart 2014	Ekzekutivni Direktor Distribucije, KEK sh.a/KEDS
08. Mart 2006 - Juni 2008	Menadžer odseka za razvoj mreže, KEK sh.a.
2003 - 08. March 2006	Inženjer za planiranje i razvoj mreže, KEK sh.a.
2002-2003	Odgovorni inženjer Energetike, KEK sh.a.
15.09.1999-2002	Inženjer za nova priključenja, KEK sh.a.
<b>Dužnosti na fakultetu</b>	



2010-2015	Asistent, Univerzitet u Prištini, Fakultet elektrotehnike i računarske tehnike.		
Decembar 2019-U toku	Vanredni profesor, Sveučilište Obrazovanje za poslovno-tehnološka (UBT), Priština.		
<b>Održani / održavaju predmeti na fakultetu</b>			
2010-2015	<ol style="list-style-type: none"> <li>1. Elektrotehnički materijali</li> <li>2. Tehnika visokog napona</li> <li>3. Prenaponi i koordinacija izolacije</li> </ol>		
Decembar 2019-U toku	<ol style="list-style-type: none"> <li>1. Sustav prijenosa i distribucije / Menadžment inženjeringa</li> <li>2. Energetska elektronika u pametnim mrežama</li> <li>3. Tehnike mjerenja</li> <li>4. Proizvodnja energije vjetra</li> <li>5. Primenjeni projekat</li> </ol>		
<b>Spisak radova sa rezultatima iz doktorske teze</b>		<b>Impact Factor</b>	<b>Cituar</b>
1.	<p style="text-align: center;"><b>“Fault current due to asynchronous connection of the generator to the grid and impact on HV circuit breaker with gas SF6”</b></p> <p><b>Objavljeno u: Tehnički Vjesnik, Technical Gazette, December 2017, Slavonski Brod, Hrvatska.</b></p> <p><b>Authors: Avni ALIDEMAJ, Sreten Škuletić, Vladan Radulović</b></p>	<b>0.64</b>	<b>6</b>
2.	<p style="text-align: center;"><b>“Internal defects of the medium voltage circuit breaker”</b></p> <p><b>Objavljeno u: CIGRE, SEERC, Priština, Kosovo, 06-08 November 2018.</b></p> <p><b>Autori: Avni ALIDEMAJ, Arif VITIJA, Nezir NEZIRI, Naser XHAMBAZI</b></p>		
3.	<p style="text-align: center;"><b>“Important Factors for Consideration during the Specification of SF6 Circuit Breakers for High Voltage Generators”</b></p> <p><b>Objavljeno u: MDPI-Energies, Basel, Switzerland, July 2020</b></p> <p><b>Autori: Avni ALIDEMAJ, Qendrim NIKA</b></p>	<b>2.702</b>	

Priština, Kosovo  
17.07.2020

Mr. Sc. Avni Alidemaj, PhD Candidate



Article

# Important Factors for Consideration during the Specification of SF<sub>6</sub> Circuit Breakers for High Voltage Generators

Avni Alidemaj<sup>1</sup> and Qendrim Nika<sup>2,\*</sup> 

<sup>1</sup> Faculty of Electrical Engineering, University of Montenegro, 81000 Podgorica, Montenegro; avni.alidemaj@ubt-uni.net

<sup>2</sup> GE Renewable Energy, General Electric International INC, 10000 Pristina, Kosovo

\* Correspondence: qendrim.nika@ge.com; Tel.: +383-49-987-603

Received: 9 June 2020; Accepted: 8 July 2020; Published: 13 July 2020



**Abstract:** This paper describes and analyzes the phenomena that occur in the case of a current interruption due to faults in the high voltage circuit breaker. That happens during connection of a generator to the network without meeting the synchronization conditions. This paper also describes and analyzes the important factors that have to be considered during the specification of SF<sub>6</sub> circuit breakers for high voltage generators. A high direct current component in the fault current poses a major problem during such interruptions. To investigate this problem and propose possible solutions, simulations were performed on a power network model completed with the network's data, using software such as EMT-P-ATP, PSS-E and MATLAB. Various modes of operation were simulated, which are important for analyzing the strain on circuit breakers near the generator. Based on the performed simulations, it can be concluded that circuit breakers with rapid reactions in interrupting the fault current in an energy system are not always a favorable solution due to the high value of the direct current component in the fault current, which prevents the current from passing through zero within a short time.

**Keywords:** direct current component; alternating current component; asynchronous connection; circuit breaker; generator; energy system

---

## 1. Introduction

The consequences of a short circuit occurring near a synchronous generator depend on the starting moment of the short circuit (SC) and the state of excitation and operation before the fault occurs. In such cases, the transient direct current (DC) component of the fault current may exceed the alternating current (AC) component, and/or the sub-transient AC component may decay faster than the DC component, resulting in the SC current not crossing zero for several cycles [1,2].

The motivation for this paper derived from a concrete problem that occurred during a specific case, as well as consideration of the advantages and disadvantages of circuit breakers (CBs) with rapid reaction (with SF<sub>6</sub> gas in some cases). Many studies have been carried out on this phenomenon. Some research dealing with a similar phenomenon that occurred in the energy system of the Republic of Kosovo (Kosovo is located in the center of the Balkans) has been provided in the references of this paper [1–5].

A mis-synchronization event of a generator on the network is one of the worst types of fault for a synchronous generator; it has negative effects both on the generator itself and on the elements of the equipment that are connected to the generator [1,3].

The intensity and severity of the consequences of activating a non-synchronized generator on a network depend on a large number of influencing parameters.

The most dominant influence is the value of the phase angle  $\delta$  between the generator's rotor and the magnetic axes of the individual phases of the stator at the moment of inclusion.



This phase angle determines the value of the fault current that contains a DC component. The generator and the network elements must be protected against the high current that occurs during such an incident, so the circuit breakers (CBs) in the network must interrupt the total fault current as quickly as possible.

The non-zero-crossing of the current can be attributed to an asymmetrical current containing a DC offset. As a result, the circuit breaker has to wait for the current to reach the zero-crossing point for an interruption to take place. This will delay the total clearing time until the current's zero-crossing is achieved. This non-zero-crossing phenomenon can delay the clearing process and can expose generating units to more stress by prolonging the duration of high current flow.

Further, this paper analyzes the effects of a mis-synchronized generator on a network that does not fulfill the necessary synchronization conditions. Special attention is given to the possibility of using a high-voltage (HV) CB to disconnect the failure currents [2,3].

An analysis was made on the power network model prepared with real data of the power network elements integrated into the electromagnetic transients program (EMTP), ATP. It is a universal software program system for digital simulation of transient phenomena of electromagnetic as well as electromechanical nature (EMTP-ATP). The simulation results were compared with real-time measured data obtained from the described real event.

The obtained results for different input parameters show a significant presence of the DC component of the current, which caused delays in the current crossing zero. As a consequence, the CBs could not disconnect the failure current beyond the time for which they were designed.

Appropriate measures are proposed to prevent such situations in case of an accidental non-synchronized activating of the generator on the network [1,2]. Therefore, various electrical relay protection systems for this kind of phenomenon have been developed to protect equipment in this mode of operation. The existence of any differences during the process of activating the generator on the network causes instant or cumulative damage to the turbine, generator, or other elements of the network [3,4].

Thus, the absence of these differences in the frequency, magnitude, and angle voltage phase is the basic condition that has to be met before activating the generator on the network [5]. When these requirements are achieved, the generator is synchronized and ready for connection to the network.

The CB must be dimensioned so that it can switch off all symmetric and asymmetric fault currents. In addition, consideration must be given to the possibility of presence of a DC component of the fault current, which plays a very important role in determining the rated values of the CB [1].

The following is a mathematical model that describes the asymmetry of the SC current due to the presence of a DC component, which makes it impossible to interrupt the fault current.

Based on Figure 1, which represents the alternating component and degree of asymmetry upon separation, in reference to the standard IEC/IEEE 62271-100 [6],  $I_{dc}$ , and  $I_{ac}$  can be calculated according to Equation (1):

$$\frac{I_{dc}}{I_{ac}} \cdot 100 = \frac{\overline{ON} - \overline{OM}}{\overline{MN}} \cdot 100 \quad (1)$$

In Equation (1) AA' and BB' are envelopes of a current wave; CC' is the shift of the zero lines of the current wave at any time; EE' is the moment of disjunction of contacts (the moment of ignition of the electric arc);  $I_{MC}$  is the shock current of SC;  $I_{ac}$  is the peak value of the AC component at the time of EE';  $I_{dc}$  is the DC component of the current at EE'; ON is the sum of  $I_{ac}$  and  $I_{dc}$  at the instant of contact separation; OM is the value of the envelope of the current-wave at the instant of contact separation; and MN is the sum of the envelope of the current-wave ON and OM at the instant of contact separation. The SC current is characterized by two values [6–9]:

The root means square (rms) value of the AC, known as  $I_{sc}$ .

The time constant  $\tau$  of the DC component of the SC current.

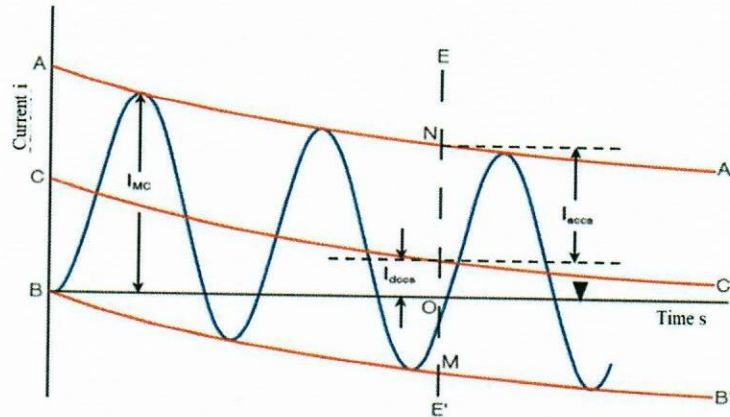

Figure 1. Alternating component and degree of asymmetry upon separation.

From the example depicted in Figure 1,  $\frac{I_{accs}}{\sqrt{2}}$  is the rms value of the AC of current,  $I_{sc}$  the instant of contact,  $\frac{I_{dccs}}{\sqrt{2}}$  is the rms value of the DC of the current, and  $A_{sycs}$  is the degree of asymmetry at the instant the contacts separate; see Equation (2):

$$A_{sycs} = 100\% \frac{I_{dccs}}{I_{accs}} \quad (2)$$

The DC component time function  $I_{ac}(t)$  is characterized by the sub-transient, transient, and steady-state currents during the sub-transient and transient time periods. These time periods are defined by the direct-axis sub-transient and transient time constants  $T''_d$  and  $T'_d$ ; refer to Equation (3):

$$I_{ac}(t) = I''_{kd} - I'_{kd}e^{-t/T'_d} + I_{kd} \quad (3)$$

The initial sub-transient and transient values of the three-phase short-circuit currents,  $I''_{kd}$  and  $I'_{kd}$ , can be evaluated using the active voltages behind the respective impedance by applying Equations (4) and (5) ( $I_{kd} = I_k$ , which is the steady-state short-circuit current, the value of which should generally be obtained from the manufacturer).

$$I''_{kd} = E''_{q0}/Z''_d = E''_{q0}/(R_a^2 + X''_a)^{1/2} \quad (4)$$

$$I'_{kd} = E'_{q0}/Z'_d = E'_{q0}/(R_a^2 + X'_a)^{1/2} \quad (5)$$

The active voltages  $E''_{q0}$  and  $E'_{q0}$  depend upon the preloaded current and can be evaluated using Equations (6) and (7):

$$E''_{q0} = [(\frac{U_0}{\sqrt{3}} \cos \Phi + R_a I_0)^2 + (\frac{U_0}{\sqrt{3}} \sin \Phi + X''_d I_0)^2]^{1/2} \quad (6)$$

$$E'_{q0} = [(\frac{U_0}{\sqrt{3}} \cos \Phi + R_a I_0)^2 + (\frac{U_0}{\sqrt{3}} \sin \Phi + X'_d I_0)^2]^{1/2} \quad (7)$$

The DC component  $i_{dc}(t)$  can be evaluated from Equation (8):

$$i_{dc}(t) = \sqrt{2}(I''_{kd}(t) - I_0 \sin \Phi_0)e^{-t/T_{dc}} \quad (8)$$

The peak value of the short-circuit current occurs between time  $t = 0$  and  $t = T/2$  of the short-circuit condition. The exact time depends on the preload conditions, the generator impedance, and the



time constants. However, it is acceptable to calculate  $i_p$  at time  $T/2$ , i.e., at the first half-cycle of the short-circuit condition, using Equation (9):

$$i_p(t) = \sqrt{2}I_{ac}(t) - I_{dc}(t) \quad (9)$$

The breaker should be capable of breaking any short-circuit current up to its rated short-circuit breaking current containing any AC component up to its rated value and, likewise, any percentage DC component up to the specified rating [9].

The DC component value as a percentage (dc%) at the moment of CB contact separation can be calculated according to Equation (10):

$$dc\% = 100 e^{-(T_{op}+T_r)/\tau} \quad (10)$$

where  $T_{op}$  presents the time of CB contact opening, which is provided by the manufacturer;  $T_r$  is the time needed for the protection relay to operate, and  $\tau$  is the decay time constant of the DC component.

For the CB with a rated SC breaking current  $I_k$ , the DC component  $I_{dck}$  at the instant of contact separation ( $T_{op} + T_r$ ) can be calculated according to Equation (11):

$$I_{dck} = I_k e^{-(T_{op}+T_r)/\tau_k} \quad (11)$$

Thus, the DC component that the CB is capable of breaking during the test is determined according to the decay time constant  $\tau_k$  on the premise that the maximum DC component equals the peak AC component at 0 s.

The standard IEC/IEEE 62271-37-013 defines a 133 ms time constant (Figure 2) for the DC component of the rated system–source SC current. Referring to Figure 2, the 133 ms constant corresponds to roughly 68% of the value of the asymmetry at the moment when the contacts are separated, e.g., at 50 ms [6].

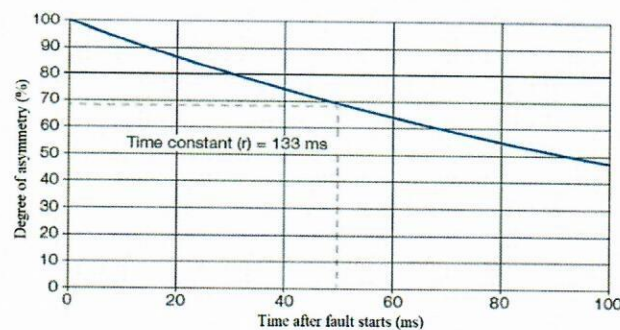

Figure 2. Degree of asymmetry depending on the time after the fault starts.

The time constant  $\tau$  can be calculated according to Equation (12):

$$\tau = \frac{X}{\omega R} \quad (12)$$

where  $X$  is the equivalent reactance of the system for the medium voltage (MV) side of the transformer,  $R$  is the equivalent resistance for the same point,  $\omega$  equals  $2\pi f$  (with system frequency  $f$ ), and  $\tau$  remains the instant at which the CB contacts separate [6–8].

The scientific novelty of the paper is a thorough analysis of the case: the connection of the non-synchronized network generator to the energy system. Although this phenomenon occurs rarely under normal operating conditions, it can be caused due to failure in CB control systems.

A real case of SC current asymmetry due to the presence of a DC component has taken place in the energy system of Kosovo. Causes and consequences of such a phenomenon and the appropriate analysis is given in following sections.

## 2. Materials and Methods

The energy system of the Republic of Kosovo is connected to international transmission lines with the neighboring countries of Albania, Montenegro, North Macedonia, and Serbia, using high voltage transmission lines with high transmission capacities of 400 kV, 220 kV, and 110 kV. This solid connection of the transmission network with the surrounding networks makes the energy system of Kosovo one of the most important electrical nodes in the region [4]. In the transmission system, various power CBs were installed by different manufacturers. In terms of the type of dielectric arc extinguishing medium, CBs with SF6 gas are the most common.

The protection relays are distant relays (Siemens (7SA612)) along with an over-current relay (7SJ612). These relays are installed in the generator field in substation 400/220 kV near the thermal power plant (TPP), “Kosovo B”. The protection devices used in this case are numerical relays to protect the short line that connects the generator to the transmission network [10–14].

During the case under consideration, real-time measurements of the current and voltage were made and recorded on the SIEMENS digital relays at the moment when the generator was connected to the network. Measurements of the DC component were also made when the CBs were switched off.

Figure 3 provides a simplified single line diagram where the main units of the generator in the TPP “Kosovo A and B” are connected. The critical circuit breaker (CB1) is also shown for when the observed event occurred [13,14].

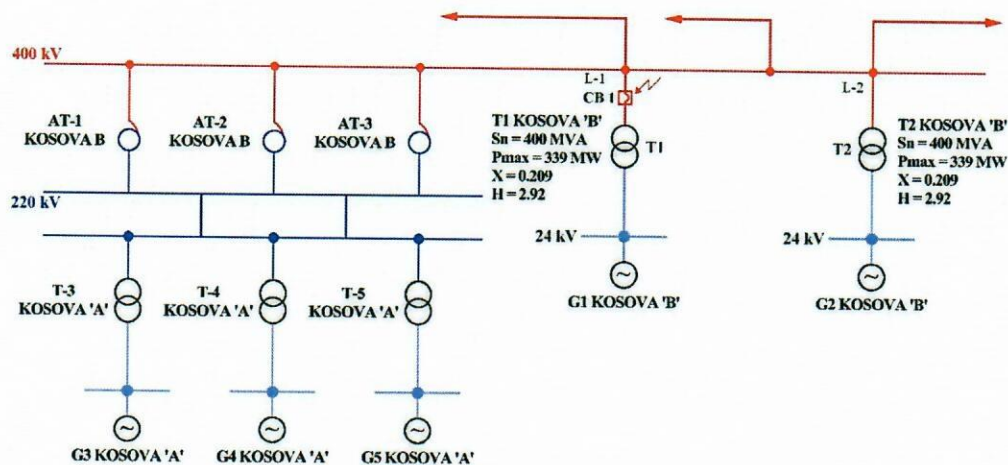

**Figure 3.** A simplified single line diagram where the main units of the generator in the TPP “Kosovo A and B” are connected. To connect the generator to a 400 kV network, a 420 kV SF6 circuit breaker (CB1) was installed, manufactured by Areva, type: GL 316, with rated current 3150 A, and short-circuit breaking current of 40 kA. The data for transformers, generators and lines from Figure 3 are given in Tables 1–3.

Table 1 shows the data for generator units in TPP Kosovo A and Kosovo B.

**Table 1.** Generator data for TPP Kosovo A and Kosovo B.

	G3	G4	G5	G1	G2
Rated Power (MVA)	235.3	235.3	235.3	399	399
Power Factor	0.85	0.85	0.85	0.85	0.85
Rated Voltage of Stator	15.75	15.75	15.75	24	24



Table 2 shows the data for transformer in TPP Kosovo A and Kosovo B.

Table 2. Transformer data for TPP Kosovo A and Kosovo B.

	T-3	T-4	T-5	AT-1	AT-2	AT-3
Manufacturer	Hyundai	Hyundai	Končar	Alstom	Siemens	Končar
Rated Power (MVA)	240	240	240	400	400	48
High Voltage (kV)	230	230	230	410	410	220
Low Voltage (kV)	15.75	15.75	15.75	24	24	0.66
Short-Circuit Voltage (%)	11.34	11.39	11.34	13	13	9.45

Table 3 shows the data for the transmission line from 400 kV substation to the generator where the study was planned.

Table 3. Transmission line data from the 400 kV substation to the generator.

L (km)	Un (kV)	Section (mm <sup>2</sup> )	R <sub>d</sub> Ω/phase	X <sub>d</sub> Ω/phase	B <sub>d</sub> μs/phase	R <sub>o</sub> Ω/phase	X <sub>o</sub> Ω/phase	B <sub>o</sub> μs/phase	
L-1	1.1	400	3 × 2 × 490/65	0.033	0.384	3.452	0.325	0.935	2.973
L-2	1.1	400	3 × 2 × 490/65	0.033	0.384	3.452	2.973	2.973	2.973

The following power network model that describes the asymmetry of the short-circuit current due to the presence of the DC component, which is the cause of the impossibility of interrupting the fault current.

Simulation data for the equivalent network (SC power at 400 kV,  $I_{k3} = 20$  kA,  $I_{k1} = 21$  kA) were taken from the simulation with PSS-E of the regional energy system of southeast Europe. In particular, simulation data were taken from short circuits in 400 kV bus-bars in the substation Kosovo B located in the energy system of Kosovo as shown in Figure 4. A SC was simulated with PSS-E on the 400 kV bus-bars where the generator is connected.

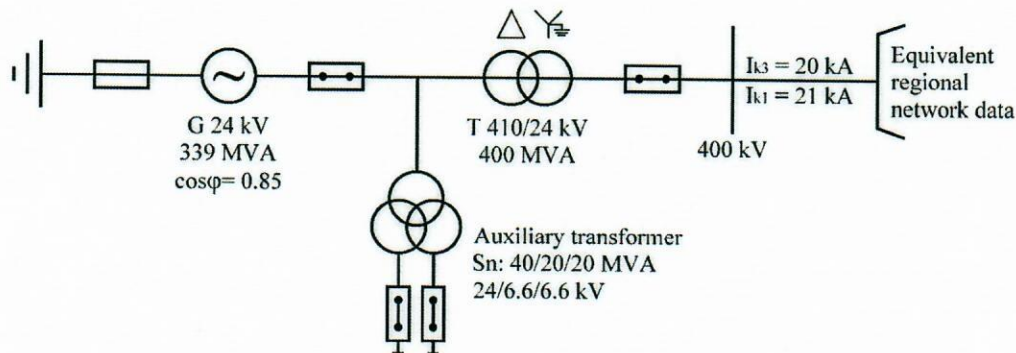

Figure 4. The simulation model scheme.

Network data for simulating an equivalent network:  $S_{k3} = 13,856$  MVA,  $S_{k1} = 14,549$  MVA ( $I_{k3} = 20$  kA,  $I_{k1} = 21$  kA). SC impedance data in substation Kosovo B is  $Z_k = 2.61 + 17.97j \Omega$ , whereas  $X/R = 6.88499$ . The  $X/R$  ratio is simply the ratio of the system reactance to the system resistance; the  $X/R$  ratio affects the level of SC current which CB is required to interrupt. Other simulation data include the generator data:  $U_n = 24$  kV,  $S_n = 399$  MVA, earthing resistor of generator  $r = 950 \Omega$ , step-up transformer:  $S_{nT} = 400$  MVA,  $uk\% = 11\%$ , 24/400 kV/kV, and auxiliary transformer:  $S_n = 40/20/20$  MVA, 24 kV/6.6/6.6 kV [14]. The SC data (in real time) was taken from transmission system operator (TSO).

The TSO uses PSS-E software for SC calculation. These data allow us to determine the equivalent network impedance that will be used for simulations with the EMTP-ATP software (Figure 4).

The scheme that is used for simulation is presented in Figure 4 [14].



For the validation of the power network model, the comparative methodology of the data recorded during the real event is used, with the data obtained from the power network model constructed with real network data at the moment when the event occurred.

### Case Study

The event under review occurred on the substation of TPP Kosovo B, where mis-synchronization of the generator with the energy system of Kosovo occurred.

To explore this phenomenon, an example featuring a situation of the random inclusion of a non-synchronized generator in Kosovo's energy system with a CB of over 400 kV is analyzed in this paper.

This situation shows that there can be significant damage to the CB [14]. The observed fault occurred in the command circuits of the generator CB, at a load of 1050 MW.

There may be damage to the control cables if the generator is switched off and then immediately switched on to the network without fulfilling the synchronization conditions [14–17].

Table 4 shows the values recorded during a time of 60 ms for  $I_{rms}$  (effective value of the current) depending on the time during the considered case [14].

**Table 4.** The effective value of current ( $I_{rms}$ ) depending on the time obtained from the relays.

T (ms)	$I_{rms}$ (kA)
−10	3.9
0	4.18
10	3.49
20	3.41
30	2.8
40	2.76

The case investigated occurred on 23 August 2011. This case was the result of accidental activation of the CB with SF6 gas without synchronizing the generator with the network due to some problems in the control circuits (failure in the generator CB control circuit). The DC component had a significant effect on the CBs and caused difficulties during the shutdown process. Switching off the current for less than 50 ms under high voltage, without the current passing through zero, can lead to damage of the CB, as CBs are not designed to break at such faults [14].

With the operation of the relay protection system, the 400 kV CB in the step-up transformer receives an exclusion order in such a case.

Phases B and C through the  $I_b$  and  $I_c$  current were interrupted at the zero crossing 3 cycles after the incident's initiation. Unlike phase A, the trace  $I_a$  current cleared in 5–6 cycles due to its delay in reaching the zero crossing. This non-zero-crossing phenomenon can delay the clearing process and expose the generating unit to more stress by prolonging the duration of the high current flow.

Switching off and current interruption occur in two phases (B and C). In phase A, the current interruption is absent because the first passage of the current through zero occurs only after the end of the shutdown operation and the arc-extinguishing attempt (Figure 5).

To explain the event, we performed simulations using a simplified simulation model, where the origin, development, and nature of the overall phenomenon are presented [14].

The DC component and its quenching depend on the time constants of the circuit at the moment of failure. For example, its quenching depends on the R/L parameters that are generated for the resistance (R) and inductance (L) of the power lines, transformers, and generators in a transmission system.

The R/L ratios determine the proper DC component decay time constants of various elements, and the overall decay of the DC components when a fault occurs depends on the combined time constants of all fault sources [14,18–20]. The presence of a high DC component value ensures that the current in phase A does not pass through zero for approximately 100 ms (the DC component and



its shutdown depend on the time constants of the circuit at the moment of failure, i.e., its shutdown depends on the generated parameters R/L).

From the recorded events of the relay shown in Figure 5, it can be seen that the current in phases B and C was switched off successfully from the CB. The oscillogram occurrence of the event, according to the record of the relay protection system in the 400 kV step-up transformer, is shown in Figure 5 [14].

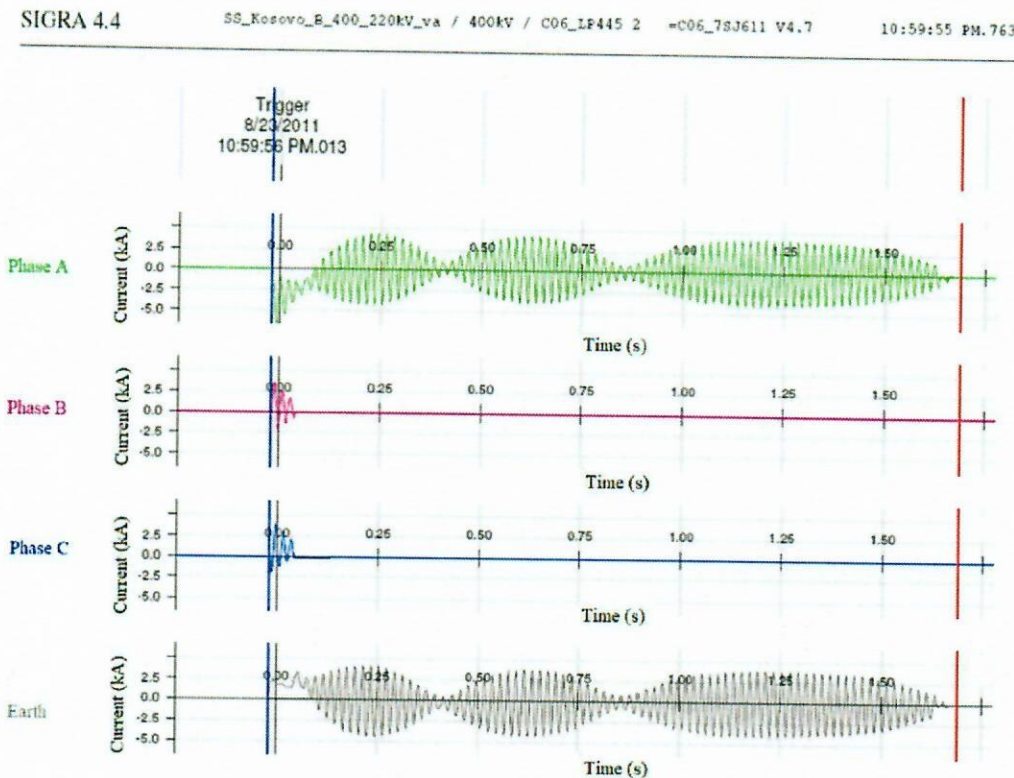

Figure 5. The over-current relay record.

Due to the failure of this CB to turn off the electric arc, there was an explosion in the CB (Figure 6), which caused great environmental damage to the neighboring elements of the substation [14]. As a result of this fault and the explosion of the CB, the following damage occurred:

- The generator was out of operation for 8 h.
- There was damage to the main contacts in a single 400 kV CB chamber.
- There was damage to three supporting isolators of the CB on adjacent transformer bays.
- There was reduction of the safe operation of the substation due to using the last generator from the generator reserve.

Figure 6 shows the damage to the main contact in a single 400 kV CB chamber [14].

The measured data show asymmetry, which was the cause of the DC component occurrence at each phase. In phase A (Figure 5), the DC component is very large, which causes the AC component to move on the x-axis.

Therefore, due to the presence of high-value DC components, the current in phase A does not pass through zero in approximately 100 ms. The type of fault and the conditions in which it occurs determine the DC component value.

The activation of a non-synchronized generator on the network causes high-current failures, such as SC current failure. Transient electrical and mechanical processes are dependent on the angle of the rotor, causing considerable stress on the generator [19–23]. The DC component of the fault current,

which occurs at that moment, causes the appearance of highly asymmetrical currents between the phases, making it difficult to break the fault current and thus extinguish the electric arc [5].

This leads to the appearance of high temperatures or even an explosion in the CB pole chambers. The state of the current as a result of accidental activation consists of two elements: periodic (AC component) and aperiodic (DC component). The aperiodic component has a high value and is particularly prominent in phase A [14].

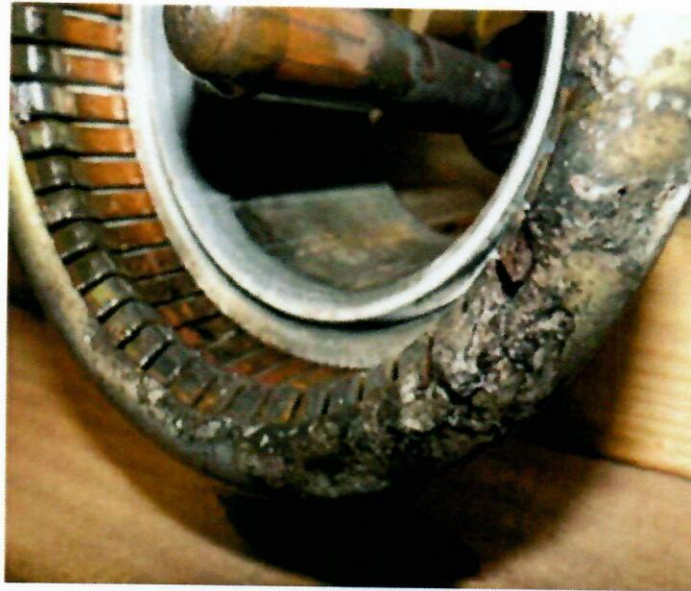

Figure 6. Damage to the main contact in the circuit breaker (CB) chamber.

### 3. Results

A simulation power network model was developed in the EMTP-ATP and Power System Simulator for Engineering (PSS-E) software package to monitor the behavior of the generator during the activation of a non-synchronized generator on the energy system at different angles between the generator and the network. The model was developed and tested based on real-time events [14,18].

To simplify the model, an equivalent network was modeled with the generator.

To validate the power network model, a simulation was used for the same phase angle of  $114^\circ$  (angle of  $114^\circ$  has been taken from the SIEMENS digital relays data), under which the activation of a non-synchronized generator in the network occurred. The simulations of these cases are given in Figures 7–12 [14,23–25].

The simulation of the critical angle of  $114^\circ$  (under which the non-synchronized generator is connected on the network) is based on the specific case that occurred, whereas the other angles ( $50^\circ$ ,  $90^\circ$ , and  $0^\circ$ ) were taken randomly to reveal what happens in those cases (for analytical purposes only).

In Figures 7–9, simulations are provided that show the oscillations of the generator network during the activation of a non-synchronized generator at a  $114^\circ$  angle separated for each phase. At the time of the non-synchronized activation of the generator to a voltage level of 400 kV on the generator side, the angle was  $59^\circ$ ; at that time the network had a phase shift of  $-55^\circ$  [14]. In this case, the difference between the angle of  $-55^\circ$  and the angle of  $59^\circ$  was  $114^\circ$ .

Thus, the 400 kV CB was switched on between these two vectors:

- $-55^\circ$  on the side of the strong network;
- $59^\circ$  on the side of the generator, yielding an angle of  $114^\circ$  between the two sides of the CB.



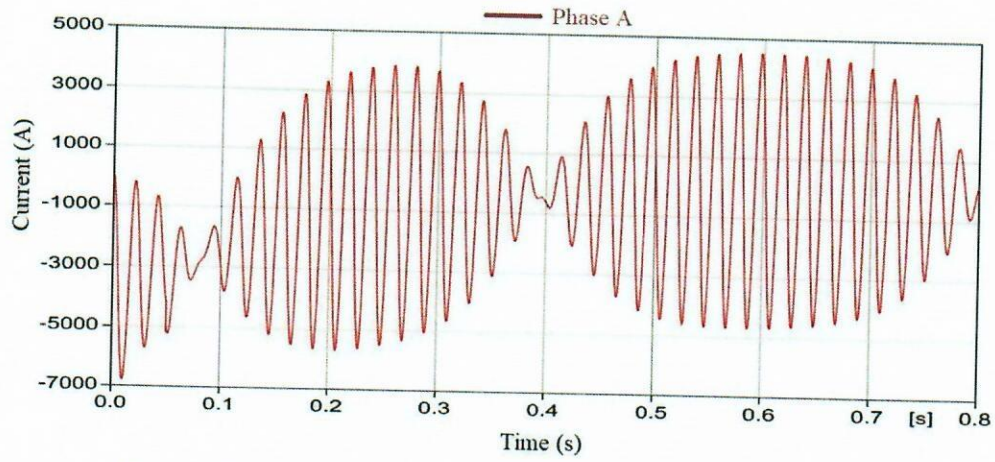

Figure 7. The curve form after the simulation of the  $114^\circ$  angle (Phase A).

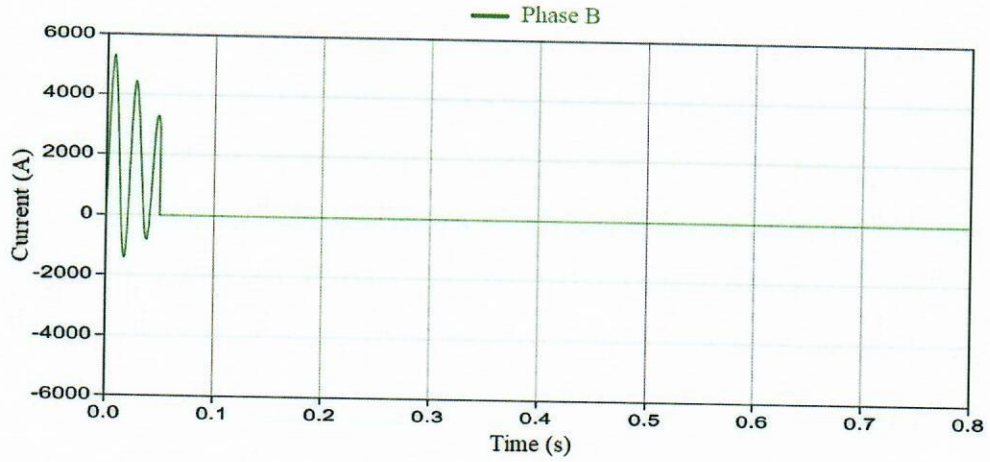

Figure 8. The curve form after the simulation of the  $114^\circ$  angle (Phase B).

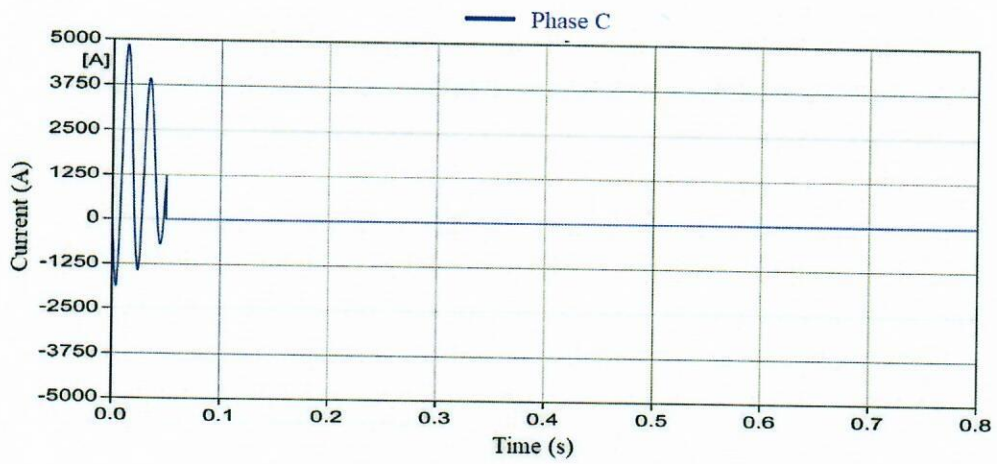

Figure 9. The curve form after the simulation of the  $114^\circ$  angle (Phase C).

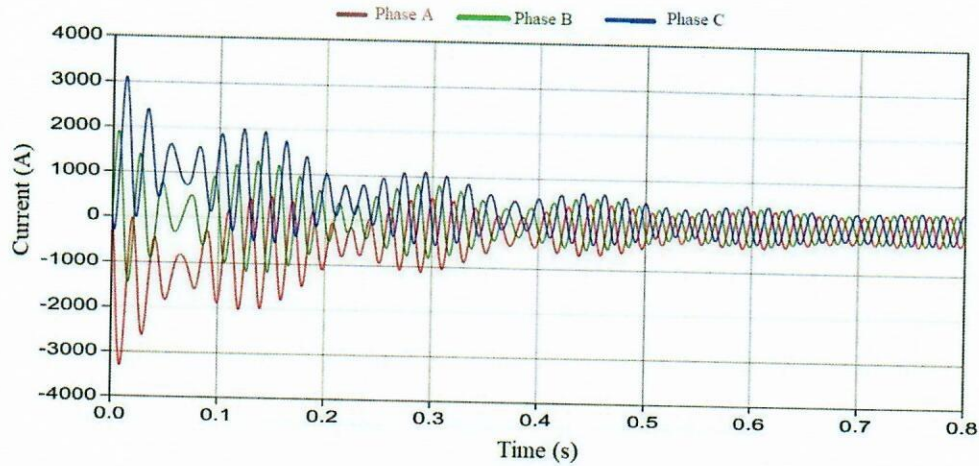

Figure 10. The curve form after the simulation of the  $50^\circ$  angle.

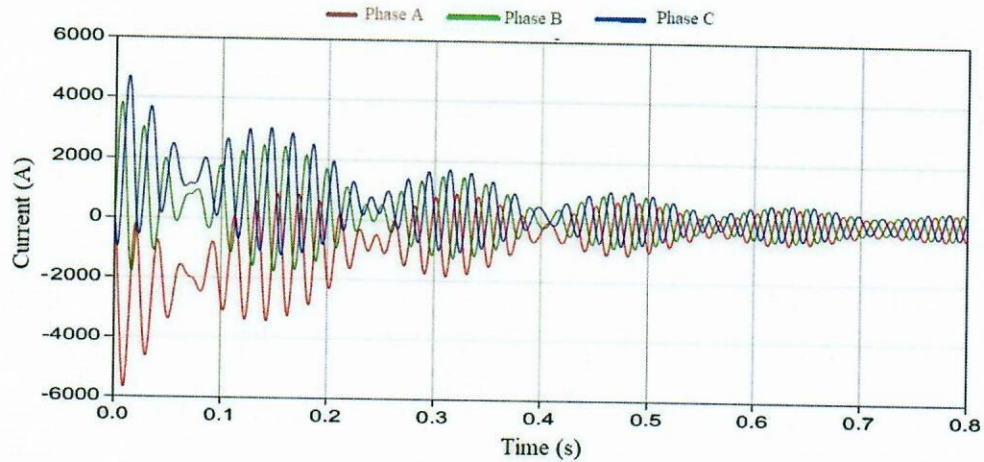

Figure 11. The curve form after the simulation of the  $90^\circ$  angle.

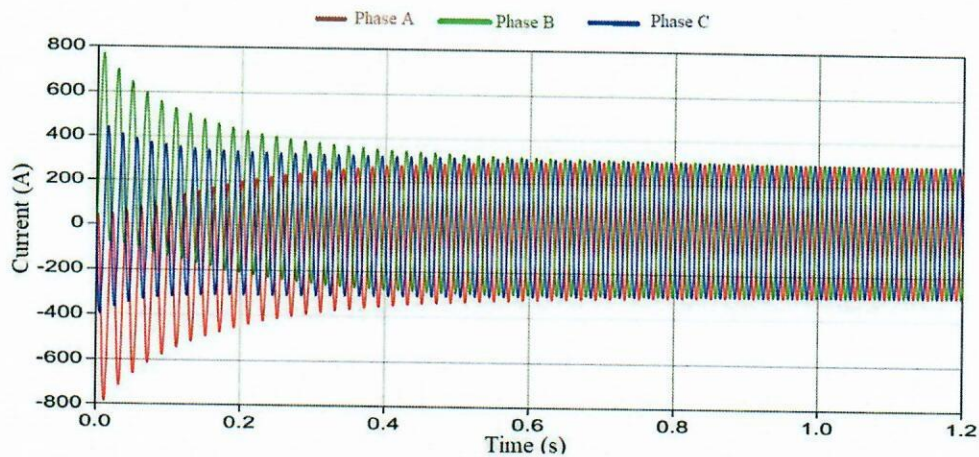

Figure 12. The curve form after the simulation of the  $0^\circ$  angle.

The results of several simulations using the implemented model show a good correlation with the results recorded during the considered event in real-time.

By analyzing the curves shown in Figures 7–9, it can be seen that the oscillation duration is approximately the same as that in Figure 5. The shape of the curve is the same as that of the DC component (very high in both cases, including the time constant).



The delay in passing the current through zero is caused mainly by the rapid movement of the rotor from the initial phase angle  $\delta = 0$ . In this case, the constant of the inertia of the generator–turbine group has a decisive influence on this phenomenon.

Notably, the current, due to the presence of a DC component, does not pass through zero (as seen in Figures 5 and 7) for a long period of time, thus presenting a problem for the AC CB during the deactivation of this current, except where the angle is zero (Figure 12) [26,27].

Table 5 shows the values determined by the EMTP-ATP. These values were extracted in MATLAB to calculate the  $I_{rms}$  (effective value of current) for an angle of  $114^\circ$ .

**Table 5.** The effective value of the current ( $I_{rms}$ ) depending on time.

T (ms)	$I_{rms}$ (kA)
−10	3.46
0	4.24
10	3.62
20	3.6
30	3.21
40	3.26

The times during the real events and simulations were synchronized concurrently to compare the obtained values. The results obtained with EMTP-ATP and the effective value of the current calculated with the MATLAB software (Figure 13, Table 5) are very close to the true recorded values (real-time events, Table 4) [2]. Table 6 gives the comparative error values in percent for the  $I_{rms}$  of the values obtained during the real event and the values obtained using a simulation with an equivalent model, as shown in Figure 13. A single line diagram of the simulation network with EMTP-ATP is shown in Figure 14.

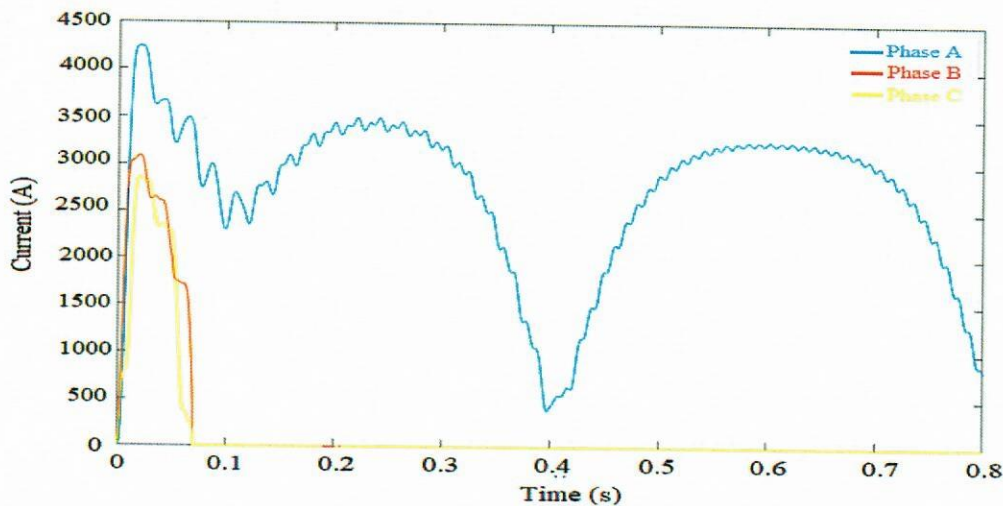

**Figure 13.** Effective current value for an angle of  $114^\circ$ .

**Table 6.** Comparative table.

T (ms)	Values Recorded during the Considered Case $I_{rms}$ (kA)	Values Determined by the EMTP-ATP and MATLAB $I_{rms}$ (kA)	Error [%]
−10	3.46	3.46	11
0	4.24	4.24	1
10	3.62	3.62	4
20	3.6	3.6	5
30	3.21	3.21	15
40	3.26	3.26	18

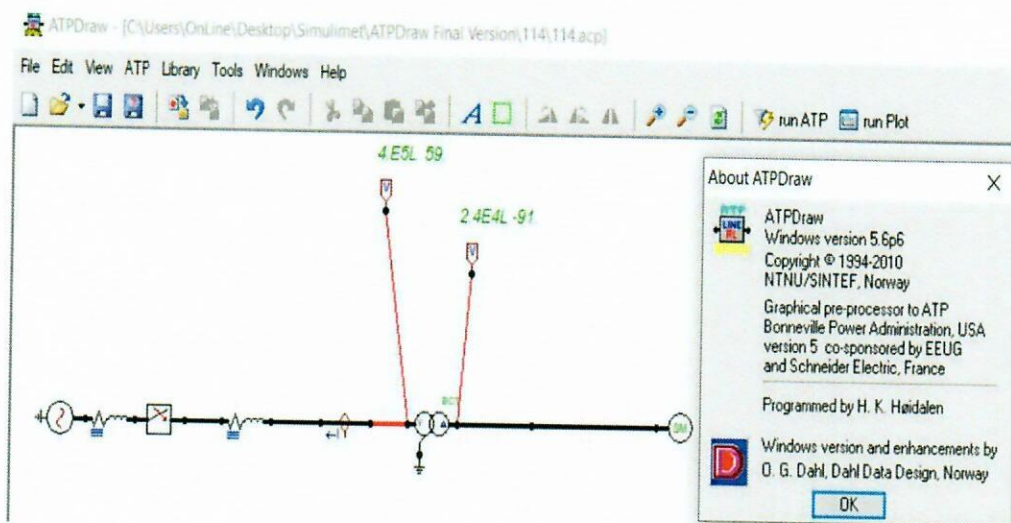

Figure 14. Single line diagram of the simulation network.

The equivalent model provides good results, as can be seen by comparing Figure 5 (real event) with Figures 7–9 (obtained through simulations) [14,25–27].

#### 4. Discussion

This paper presents an analysis of the phenomena that accompany the process of switching on a non-synchronized generator on a network from the perspective of the occurrence of current and voltage. Special attention has been given to the event that took place in the energy system of Kosovo on 23 August 2011—more specifically, in the TPP Kosovo B.

This phenomenon rarely occurs in practice but can also occur as a result of various faults in the CB control and command circuits. As a result of this activation, the consequences can vary, depending on how and when a non-synchronized activation took place. These oscillations are characteristic of the shape of the curve with the presence of a high DC component of the current, which affects the time delay of the alternating current component to pass through zero.

The scientific novelty of the work is its all-encompassing analysis of a specific case: the connection of a non-synchronized network generator to a power system. Although this situation rarely occurs under normal operating conditions, it can be caused due to a failure in circuit breaker control systems.

The consequences at the substation can be significant. Therefore, it is necessary to analyze the phenomena that occur in such a case to provide input data for the adequate selection of equipment.

In this paper, we analyzed the effects of the rapid shutdown of a generator from the system and the possibility of applying time delays for the operation of the CBs in these specific cases, which have an impact on the elimination of the DC components and the passage of the fault current through zero.

Thus, we presented the advantages and disadvantages of applying the time delay to disconnect the circuit breaker in these circumstances of device failure.

An additional contribution is our development of a model that provides results comparable to the real data recorded during the real event and can be used to analyze different cases for the selection of CBs in the energy system.

#### 5. Conclusions

Recordings of behavior during this event show the presence of a DC component with a large value. This does not allow the SC current to pass through zero for several tens of ms, which resulted in serious damage to one pole of the CB.

This non-zero-crossing phenomenon can delay the clearing process and expose the generating units to more stress by prolonging the duration of high current flow.



A detailed analysis of the behavior of the generator on the network during various failures is very important to determine an appropriate CB to cover all the conditions that can occur in the system during various faults, to protect the elements of the power system.

High-voltage CBs with SF<sub>6</sub> gas that are used for generators have special requirements compared to other CBs. In particular, they must be able to interrupt the fault currents that do not pass through zero in several cycles.

By comparing the time shapes of the SC currents in the case of non-synchronous switching, it can be seen that the currents have very high amplitudes, where the waveform of the current depends on the angle of the generator compared to the network.

In the case where the voltage angles of the generator and the network are zero, the direct current component rapidly declines, and all three-phase currents pass through zero, which allows for the rapid shutdown of the electric arc.

Other angles are different because, due to the presence of a direct current component of high-value currents in certain phases, the passage through zero is delayed. In our case, the time delay was 200 ms, which caused the electric arc in the CB, which could cause damage to the CB in some cases.

If the CB is installed to connect the power plant to the network, then a higher time constant should be used. Thus, a breaker with a higher permissible DC component percentage of the SC current or a CB with a higher braking power should be selected.

The consequences of adding this delay should be further analyzed in the context of their effects on other elements of the system, including transient stability.

The quick deactivation of relay protection by generator switches is not an advantage in all situations, which should also be taken into account. In the observed case, for example, a switch-off delay would have allowed the DC component to pass through zero, allowing the switch to deactivate this fault without any problems during the activation of a non-synchronized generator in the network.

**Author Contributions:** Project administration, A.A.; resources, A.A.; software, Q.N.; supervision, A.A.; visualization, Q.N.; writing—original draft, A.A.; writing—review and editing, Q.N. All authors have read and agreed to the published version of the manuscript.

**Funding:** This research received no external funding.

**Conflicts of Interest:** The authors declare no conflict of interest.

## References

1. Kizilcay, M. Breaking capability of an SF<sub>6</sub> circuit breaker for short circuits close to a generation unit with delayed current zero crossing. In Proceedings of the International Conference on Power Systems Transients (IPST2011), Delft, The Netherlands, 14–17 June 2011.
2. Javid, Z.; Li, K.-J.; Sun Kaiqi Unbreen, A. Cost-effective design of high voltage impulse generator and modeling in matlab. *J. Electr. Eng. Technol.* **2018**, *13*, 1346–1354. [[CrossRef](#)]
3. Chmielewski, T.; Oramus, P.; Szewczyk, M. Circuit breaker models for simulations of short-circuit current breaking and slow-front overvoltages in HV systems. *Electr. Power Syst. Res.* **2017**, *143*, 174–181. [[CrossRef](#)]
4. Liu, W.; Liu, Y.; Niu, S. Assessment method for substation capacity credit of generalized power source considering grid structure. *Sustainability* **2017**, *9*, 928. [[CrossRef](#)]
5. Cho, G.-J.; Park, J.-K.; Sohn, S.-H. Development of a leader-end reclosing algorithm considering turbine-generator shaft torque. *Energies* **2017**, *10*, 622. [[CrossRef](#)]
6. IEC (International Electrotechnical Commission). *IEC Technical Report 62271–306: Guide to IEC 62271–100 IEC 62271–1, IEC 62271–37-013 and Other IEC Standards Related to Alternating Current Circuit Breakers*; IEC/TR: Geneva, Switzerland, 24 December 2012.
7. Fan, Y.; Wu, L.; Qiu, H.; Qian, H.; Chen, D.; Wen, W.; Liu, S. Research on lightning surge overvoltage of convertor station with 500 kV hot-standby circuit breakers. *IET Sci. Measur. Technol.* **2015**, *9*, 900–907. [[CrossRef](#)]
8. Wei, C.; Yongsheng, W.; Wenqing, Z. Analysis on DC component in short-circuit current of power grid and its influence on breaking ability of circuit breakers. *Power Syst. Technol.* **2012**, *36*, 283–287.



9. Panji, P.A.A.; Raditya, A.H.; Indrawan, T. Short-circuit current calculation application for A.C 3 phase on marine and mobile offshore installations based on IEC-61363 standard. In Proceedings of the 10th International Conference on Marine Technology, MARTEC 2016, Dhaka, Bangladesh, 9–10 December 2016.
10. ABB. AP\_Generator Circuit Breakers (EN). 1VCP000643–Rev. A, 4 September 2017.
11. Canay, I.M.; Braun, D.; Köppl, G.S. Delayed current zeros due to out-of-phase synchronizing. *IEEE Transact. Energy Convers.* **1997**, *13*, 124–132. [CrossRef]
12. Das, J.C. Study of generator source short-circuit currents with respect to interrupting the duty of generator circuit breakers, EMTP simulation, ANSI/IEEE and IEC methods. *Int. J. Emerg. Electr. Power Syst.* **2008**, *9*, 112–121. [CrossRef]
13. Kapetanović, M. *High Voltage Circuit Breakers*, 2nd ed.; ETF: Sarajevo, Bosnia and Herzegovina, 2011; pp. 235–265, 347–413.
14. Institute of Electric Power and Energy. *Thermal Power Plant Kosovo B Review of the Considered Event*; Exor: Zagreb, Croatia, 2011.
15. Lin, L.; Wang, B.; Qi, J.; Chen, L.; Huang, N. A novel mechanical fault feature selection and diagnosis approach for high-voltage circuit breakers using features extracted without signal processing. *Sensors* **2019**, *19*, 288. [CrossRef] [PubMed]
16. Bhole, A.A.; Gandhare, W.Z. An overview of dynamic contact resistance measurement of HV circuit breakers. *J. Inst. Eng. (India)* **2015**, *97*, 219–226. [CrossRef]
17. Liu, H.; Wang, Z.; Yang, J.; Li, B.; Ren, A. Circuit breaker rate-of-rise recovery voltage in ultra-high voltage lines with hybrid reactive power compensation. *Energies* **2018**, *11*, 100. [CrossRef]
18. Filipović-Grčić, B.; Uglješić, I.; Bojić, S. Analysis of transient recovery voltage in 400 kV SF6 circuit breaker. *Int. Rev. Electr. Eng.* **2011**, *6*, 2652–2658.
19. Im, J.-H.; Song, S.-H.; Park, C.-S. Maintaining PCC voltage in a distributed generation system even during power output fluctuation and unbalanced voltage conditions. In Proceedings of the 9th International Conference on Power Electronics and ECCE Asia (ICPE 2015-ECCE Asia), Seoul, South Korea, 1–15 June 2015.
20. PC37.06.1/D5, IEEE draft recommended practice for preferred ratings for high-voltage (>1000 volts) AC circuit breakers designated definite purpose for fast transient recovery voltage rise times. *Inst. Electr. Electron. Eng.* **2017**, 1–27.
21. IEEE standard for AC High Voltage Generator Circuit breakers Rated on a Symmetrical Current Basis; Amendment 1: Supplement for Use with Generators Rated 10–100 MVA. C37.013: 2007, 5 December 1997.
22. CEI. High Voltage Alternating-Current Circuit Breakers. 05/2001. CEI IEC 62271-100, 1 May 2013.
23. Transmission System and Market Operator. Available online: <https://www.kostt.com/OST/TechnicalCodes> (accessed on 28 May 2020).
24. Nadeem, M.H.; Zheng, X.; Tai, N.; Gul, M. Identification and isolation of faults in multi-terminal high voltage DC networks with hybrid circuit breakers. *Energies* **2018**, *11*, 1086. [CrossRef]
25. Alidemaj, A.; Škuletić, S.; Radulović, V. Fault current due to asynchronous connection of the generator to the grid and impact on HV circuit breaker with gas SF6. *Tehnički Vjesnik* **2017**, *24*, 1813–1819. [CrossRef]
26. Li, J.; Zheng, T.; Wang, Z. Short-circuit current calculation and harmonic characteristic analysis for a doubly fed induction generator wind turbine under converter control. *Energies* **2018**, *11*, 2471. [CrossRef]
27. Zhou, N.; Wu, J.; Wang, Q. Three-phase short-circuit current calculation of power systems with high penetration of VSC-based renewable energy. *Energies* **2018**, *11*, 537. [CrossRef]





# FAULT CURRENT DUE TO ASYNCHRONOUS CONNECTION OF THE GENERATOR TO THE GRID AND IMPACT ON HV CIRCUIT BREAKER WITH GAS SF6

Avni Alidemaj, Sreten Škuletić, Vladan Radulović

The description and analysis of phenomena that occur in case of disconnection of fault currents with generator circuit breakers after asynchronous connection of a generator and difficulties encountered during the process of disconnection are given in the paper. Generally, the biggest problems occur during the interruption of the fault when the direct current component (DC) is very high. DC component value depends on the type and conditions of the fault. For this purpose, a real study case with accidental asynchronous connection of generator via 400 kV circuit breaker is given from the Kosovo Power System which seriously damages the circuit breaker. For the purposes of this analysis, the real case situation has been also modelled with software such as: EMTP/ATP and PSS/E. It is important to emphasize that during using the high speed AC circuit breaker in power system it is not always the advantage to make successful disconnection of failures through High Voltage Circuit Breaker due to the presence of the high value DC component and the delay of passing of AC current through zero. For the generator the most important is detail analysis of behaviour of the generator in network in order to specify proper circuit breaker that can cover all circumstances that can happen in the system so to be able to protect the generator, step up transformer and other equipment.

Original scientific paper

**Keywords:** AC component; asynchronous connection; DC component of fault current; high voltage generator circuit breaker; short circuit

## Struja kvara uslijed asinkronog priključka generatora na mrežu i njen utjecaj na visokonaponski prekidač s plinom SF6

U radu su dani opis i analiza fenomena koji se događaju u slučaju isključenja struje kvara generatorskim prekidačima nakon asinhronog priključenja generatora i poteškoćama tokom procesa isključenja. Općenito, najveći problemi se javljaju tokom prekida kvara kada je komponenta istosmjerne struje (DC) vrlo visoka. Vrijednost DC komponente ovisi o vrsti i uvjetima kvara. U cilju analize ovog fenomena, u radu je analizirana situacija slučajnog asinhronog priključenja generatora preko 400 kV prekidača u elektroenergetskom sustavu Kosova koja je dovela do oštećenja prekidača. Za potrebe analize, ovaj slučaj je modeliran u softverskim paketima EMTP/ATP i PSS/E. Važno je napomenuti da uporaba brzih AC prekidača u elektroenergetskom sustavu nije uvijek prednost za omogućavanje uspješnog isključenja kvara pomoću visokonaponskog prekidača, zbog prisustva DC komponente s visokim vrijednostima i zakašnjenja prolaza AC struje kroz nulu. Za generatore je najvažnija detaljna analiza ponašanja u mreži kako bi se odredile optimalne karakteristike prekidača u svim okolnostima koje se mogu dogoditi u sustavu, kako bi se omogućila pravilna zaštita generatora, step up transformatora i druge opreme.

Izvornomi znanstveni članak

**Ključne riječi:** asinkrono priključenje; generatorski prekidač visokog napon; komponenta istosmjerne struje kvara (DC); komponenta izmjenične struje (AC); kratki spoj

## 1 Introduction

During certain faults in the power system there are cases where fault currents delay passing through zero. This occurs when the value of DC current component of the fault current is high and with the long time delay. Furthermore the high values of DC component of current occur also in cases of generator connection to the grid without fulfilling synchronization conditions. The connection of the generator to the grid without meeting synchronization conditions happens very rarely. So, connection without synchronizing condition is accidental and among other things can be a result of failure on control circuits which enable connection of the generator to the grid. Consequences of asynchronous connection of generator to the grid can be different depending on how and in which time has been a closing. Various analyses regarding the phenomenon of appearance of DC component and problems that appear during tripping of the circuit breaker are dealt with in the chapters bellow.

This paper presents analysis of the performance of circuit breaker in disconnection of the failure currents that appear as a result of asynchronous connection of the generator on the grid. The analysis was focused on a real case of presence of DC component of current during asynchronous connection of generator to the network. In addition, the changes of the voltage and current values for further investigation of such problems are recorded.

The work is based on the case of accidental closing of the circuit breaker without synchronization of generator to the network, because of failure on the control circuits of generator circuit breaker. This event took place in Kosovo power system. Detailed characteristics will be given in the following chapters. Furthermore the case is modeled using ATP and PSS/E software and results are compared with values recorded in real time of the voltages and currents. The simulation was conducted with ATP and PSS/E software. Furthermore the behavior of the generator during asynchronous connection to the network will be proven from different angles. At the end of the paper the conclusions and recommendations are given, [1].

## 2 Asynchronous Connection of Generator-Theoretical Background

In the power system, synchronization of the generator to network is the process of matching the voltage, frequency and angles of a generator and network. There are three conditions that must be met before the synchronization process takes place, [2].

Synchronous conditions should be attained with the minimization of the following parameters:

- Frequency difference between the two so called "slips"



- Voltage difference in voltage magnitude between the two sources
- Voltage difference in phase angle between voltages of the two sources

If the synchronization conditions are not met then the damages can happen such as:

- The damages that occur to turbine, generators as results of faulty synchronizing can be either immediate or cumulative (loss of life)
- The excessive slip in frequencies even with zero phase angle and voltage amplitudes, causes power to flow in or out of the generator. The direction of the power flow will be out of the machine if its frequency is greater than the network, or into machine if its frequency is less than the network. The amount of power flow increases as the mismatch increases. This type of oscillation can have consequences in shaft fatigue, bearing failure, fillet and keyway failure, turbine blade root streets, overheating due to high stator currents etc.
- A large voltage difference between sources will cause a flow of reactive power with direction of the flow depending on the relative voltage from the higher to the lower voltage.

Any case when switching on without prior fulfilling of the abovementioned criteria is considered as switching without synchronization. These cases can happen if there is any fault on control circuit, accidental operation etc.

### 2.1 Synchronization with Phase Discrepancy of the Generator into the Grid

In the following are given equations which describe changing of DC and AC (alternative current) components of the current during asynchronous connection of the generator to the network. In this case the AC and DC component of the current changes as per Eqs. (1), (2) and (3):

$$i_{dc} = \frac{2u_g}{x''_d + x_{Tr} + x_N} \sin\left(\frac{\theta_{max}}{2}\right) \cdot e^{-\frac{t}{T_{atot}}} \quad (1)$$

$$i_{ac} = \frac{2u_g}{x''_d + x_{Tr} + x_N} \sin\left(\frac{\theta}{2}\right) \quad (2)$$

Where  $i_{dc}$  is the value of the dc component at any instant, and  $i_{ac}$  is the value of the ac component at any instant.

Time constant of DC:

$$T_{atot} = \frac{x_2 + x_{Tr} + x_N}{(r_a + r_{Tr} + r_N)2\pi f_n} \quad (3)$$

The component of AC current is reduced by change of rotor angle. The circuit breaker has to be able to disconnect all symmetrical and asymmetrical currents associated with presence of high DC current component.

In this context, the very important component of faults current is the DC component. Therefore, it is

important to model and determine the DC component of current that needs to be considered in the system so that all types of failures can be covered in order to avoid causing of any damages to breakers, generator and network, as presented in [2, 3, 13].

### 2.2 Impact of Asynchronous Connection of Generator into the Grid.

During connection of large generators to the network transient electrical and mechanical processes appear. The electromechanical transient processes can cause stress on the generator. If the generator is connected to the network accidentally without respecting synchronization conditions, currents can be very high in range of short circuits. The DC component of current will appear and this can cause high asymmetry of currents between phases. The magnitude of magnetic flux inside generator depends on the position of the rotor's angle against the stator. Since the generator runs with different regimes before failure happens in the moment of failure the flux that occurs does not change immediately. Depending on the type of the failure, the DC component of current can vary.

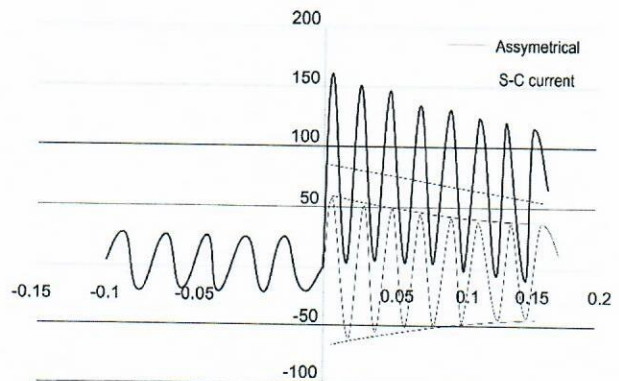

Figure 1 DC component of asymmetrical current on generator-sourced during failure

However, DC component is present also during short circuits. In case of short circuit between the generator-sourced in general the current changes as per the graph provided in Fig. 1 and it is given by Eq. (4). The magnitude of DC component of the failure depends on the type of the failure as well as on the moment when the failure occurs, respectively, on the position of the rotor's angle against the stator [4, 9, 10, 11].

The asymmetric current is expressed with Eq. (4):

$$I_{scgen} = \frac{P\sqrt{2}}{V\sqrt{3}} \cdot \left\{ \left[ \left( \frac{1}{x''_d} - \frac{1}{x'_d} \right) \cdot e^{-\frac{t}{T_d}} + \left( \frac{1}{x'_d} - \frac{1}{x_d} \right) \cdot e^{-\frac{t}{T_d}} + \frac{1}{x_d} \right] \cdot \cos\omega t - \frac{1}{x''_d} \cdot e^{-\frac{t}{T_d}} \right\} \quad (4)$$

- $I_{scgen}$  - short circuit current
- The first term is normal-frequency decaying sub transient current



- The second term is normal-frequency decaying transient current
- The third term is steady-state short-circuit current
- The fourth term is asymmetric decaying dc current.
- $x''_d, x'_d, x_d$  are direct axis sub transient, transient and synchronous reactance of system.
- $T''_d, T'_d, T_d$  are sub transient, transient and synchronous Time constants of system

The DC current component is given by Eq. (5):

$$I_{dc} = (\sqrt{2} \cdot I_{scgen}) \cdot e^{-\frac{t}{T}} \quad (5)$$

In Fig. 2 is presented the DC component of current generator-source during short-circuit current for leading or lagging load current (before failure the system is working under inductive/capacitive load) prior to short-circuit.

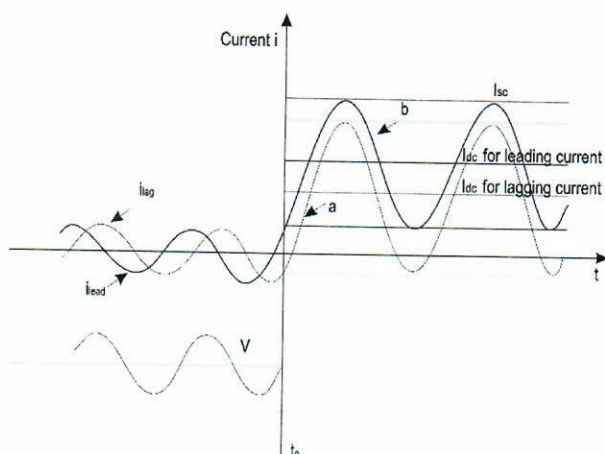

Figure 2 DC component of current in generator during short-circuit for inductive/capacitive load current prior to failure

On the generator side the maximum asymmetric current is reached when the generator is working under excitation before the failure occurs. In these conditions the DC component could be higher than the symmetric short circuit component, hence it influences the delay of the general current short circuit to pass through zero, [3, 14].

### 2.3 Comparison of required interrupting capability in case of failures

#### 2.3.1 Required Generator-source Asymmetrical Interrupting Capability for Three-phase Faults

For three-phase faults, the required asymmetrical generator-source interrupting capability of a generator circuit breaker at rated maximum voltage and for the rated duty cycle is composed of the rms generator-source symmetrical current and a DC component. The value of the DC component is 110 % of the peak value of the symmetrical generator source short-circuits current for all generator circuit breaker primary arcing contact parting times. The primary arcing contact parting time shall be considered equal to the sum of 1/2 cycle plus the minimum opening time of the particular generator circuit breaker [4, 5, 12].

#### 2.3.2 Required Generator-source Asymmetrical Interrupting Capability for Maximum Required Degree of Asymmetry

Interruption of current from circuit breaker in different circumstances including also a transient condition is presented in the IEC 62271-100, High-voltage switch gear and control gear-Part 100: High-voltage alternating-current circuit-breakers, [4, 5, 6]. The rated short-circuit breaking current is characterized by two values:

(1) The rms value of its symmetrical component; the DC time constant of the rated short-circuit breaking current which results in a percentage of DC component at contact separation.

(2) The symmetrical component and the percentage of DC component at any time following current initiation, is presented in Fig. 3, the DC component at contact separation is determined by Eq. (6):

$$I_{DC} = I_{AC} \cdot e^{-\frac{T_r + T_o}{\tau}} \quad (6)$$

Where:  $T_o$  is minimum opening time declared by the manufacturer;  $T_r$  is relay time (0.5 cycle; 10 ms for 50 Hz and 8.3 ms for 60 Hz);  $\tau$ -DC is time constant of the rated short-circuit current (45, 60, 75 or 120 ms), IAC-peak value of symmetrical current [7, 8, 15].

### 3 Case Study

In the year 2011 in substation Kosovo B there was an asynchronous connection of the generator to the grid. The generator was operating normally until the moment the accident occurred. As a result of the faults of the control circuits that control the high voltage 400 kV circuit breaker between the unit – generator- transformer in the network, there was tripping of the circuit breaker. The reconnection was done without respecting synchronization conditions.

The generator is connected to the network by accident under the changing angle of  $114^\circ$ . In these circumstances the maximum value of asymmetric current is 130 % of the peak value of symmetric on this case. In table 1 are given the values recorded during the time of 70 ms. Every 10 ms the size of the currents is measured, respectively AC and DC current component.

Table 1 AC and DC component of current depending on time

T (ms)	Current			
	$I_{rms}$ (kA)	$I_{DC}$ (kA)	DC (%)	$I_{AC}$ (kA)
-20	0.44	0.15	72	0.21
-10	3.9	2.81	110.9	2.54
0	4.18	3.6	169	2.13
10	3.49	3.11	198.3	1.57
20	3.41	3.07	205.9	1.49
30	2.8	2.61	260	1.0
40	2.76	2.6	278	0.93
50	2.28	2.21	406	0.54

The symmetrical component of the short-circuit current under the condition of maximum degree of asymmetry is only 74 % of the value of the required



generator-source symmetrical interrupting capability based on recorded measurement which is presented in Tab. 1.

The variation of value of the DC component depends on the time constant of the circuit  $T_a = X''_d/R_a$ , as presented in Fig. 3 [9].

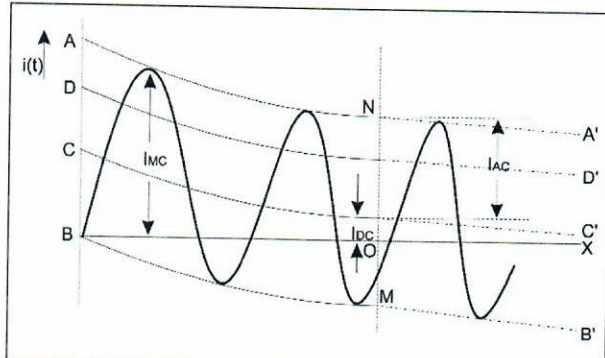

Figure 3 IEC 62271-100, Determination of short-circuit making and breaking currents, and of percentage DC component

### 3.1 Overview of Power System of Kosovo

Power System of Kosovo is a small power system, strongly interconnected with other part of the South East Network of Europe. Geographic position and configuration of the network makes the Kosovo Network very important for the Power System in the region. The main units of generation are connected to the same node (Fig. 4). Because of the size and stability, electrical generators are mainly connected to the substation (SS)

Kosovo B at 400 kV level. High voltage circuit breakers that are in general use in the Kosovo Power System at HV level are circuit breakers with gas SF6. Before the fault happened, the generator operated with the load around 270 MW. The fault happened in the generator circuit breaker (CB1 in Fig. 4) on HV voltage side. The wave of current and voltages was recorded by electronic intelligent devices (IED) type Siemens 7SA621 and 7SJ612 located in the SS 400/220 kV on generator bay of TPP Kosovo B, as presented by the single line diagram in Fig. 4, [16].

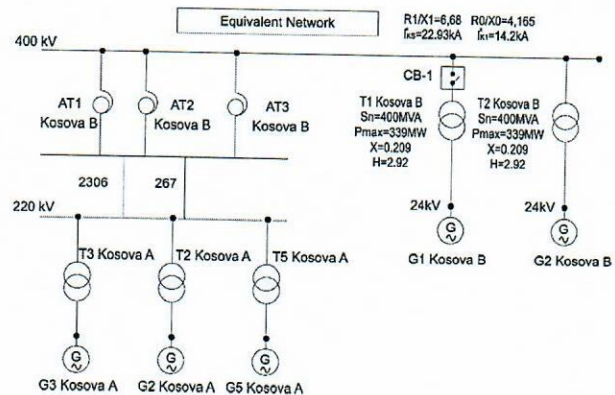

Figure 4 The simplified scheme of connection of the main generators in Power system of Kosovo

Following are the tables with parameters lines and generators in the TPP Kosovo A and B.

Table 2 Dynamic parameters of Turbo generators 399 MVA, 24 kV in Power station Kosovo B

$S_{base}$	$Z_g(p.u)$	T'D0	T''D0	T'Q0	T''Q0	H	Bm	XD	XQ
400	0.005+j0.209	6.5	0.041	0.27	0.032	2.92	1	2.214	2.093
X'D	X'Q	X''D	XL	S(1.0)	S(1.2)				
0.356	0.54	0.209	0.13	0.03	0.4				

Table 3 Dynamic parameters of TPP Kosova A3, A4 and A5 generators

$S_{base}$	$Z_g(p.u)$	T'D0	T''D0	T'Q0	T''Q0	H	Bm	XD	XQ
240	0.005+j0.188	6.8	0.15	0.032	0.032	2.98	1	1.93	1.62
X'D	X'Q	X''D	XL	S(1.0)	S(1.2)				
0.31	0.47	0.188	0.15	0.03	0.4				

Table 4 Parameter of Overhead Power Lines (OHL) 220 kV

Line Number	$Z_d (R_d+X_d) \Omega$	$Z_o (R_o+X_o) \Omega$
Line 2306 -220 kV	0.22+j1.527	1.02+j3.08
Line 267 -220 kV	0.208+j1.443	0.964+j2.910

### 3.2 Critical Event

Before closing the generator to the network any event or any fault were recorded on the system. The failure was due to fault on control circuits used for switching control of high voltage generator circuit breaker. Due to control cable damage, the generator tripped respectively HV circuit breaker of generator switched off and switched on immediately respectively connected the generator to network without respecting the synchronization conditions and tripped again from protection device. The time between two sequences of open – close of circuit breaker was around 170 ms. Final process opening contact of circuit breaker is presented in Fig. 6. As a

consequence, due to this asynchronous connection and the wide voltage angles between the generator and the power system, extremely high transient currents comparable to fault currents during short circuits.

From the oscillographic recording in Fig. 5 it can be concluded that currents on phases L1, L2 and L3 are asymmetric. Asymmetry is caused due to the presence of DC component in each phase. In phase L1, in figure 5 surrounded by square, DC component is very high and as a consequence it causes displacement of AC component of the current above the axis and delay the current of phase L1 passing through zero for approximately 100 ms.

Disconnection of the current in this case with high speed circuit breaker, is difficult because current does not pass through zero for 100 ms. High speed circuit breaker has capability to interrupt the current for less than 50 ms, but the fault current must pass through the zero. If the current does not pass through zero during the time less than 50ms, then trying to interrupt this current will be



difficult or the breaker will be damaged. In our case, the circuit breaker with time constant of 45 ms was damaged.

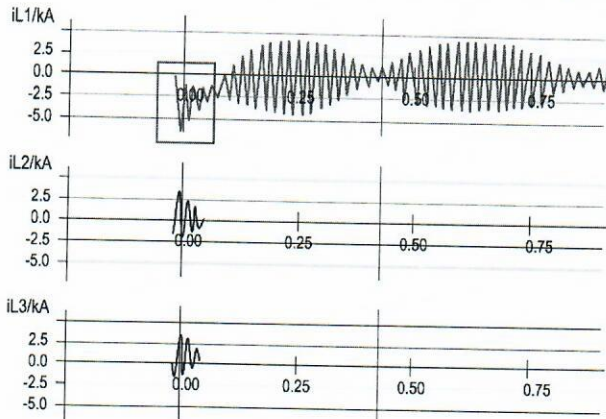

Figure 5 Oscillogram of currents on high voltage 400kV of generator step-up transformer during close-open of Circuit breaker

Fig. 6 shows the damaged main contact in one chamber of the 400 kV generator circuit breaker, [16, 17]. The insulation of one pole of the circuit breaker is destroyed as consequences of the arc flashing appears at every 400 to 600 ms.



Figure 6 Circuit breaker contacts showing damage caused by electric arc

#### 4 Simulation Results

In this part of the study we have developed the model of the part of the system described in case study. The data of the model were used from the characteristics of equipment and case observed.

##### 4.1 Model Description

The model of the system is made with ATP software and given in Fig. 8, arc is not considered and it is not modeled in ATP simulation. The system source was modeled with short-circuit current and the highest rms value of the symmetrical component of the polyphase short-circuit (short circuit from source side on bus 400 kW, is  $I_{k3}=20$  kA,  $I_{k1}=21$  kA). The generator is modeled with dynamic parameters. The results of simulations are shown in Figs. 8÷13.

The scheme of simulation is presented in Fig. 9.

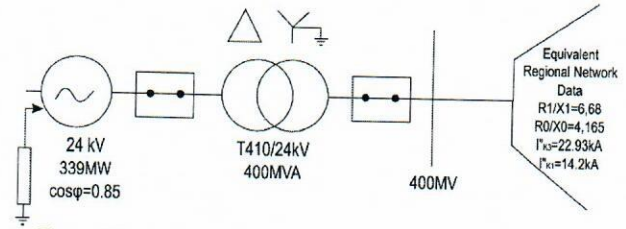

Figure 7 Real scheme of the generator in which fault happened and which is used for simulations

Figs. 8÷13, present the simulation results with ATP software. The simulation is performed for asynchronous connection of generator to the network for different displacement angles between generator and power system. Simulations are performed for different angles between network and generation including an angle of  $114^\circ$  degree. Angle  $114^\circ$  is the angle where the incident occurred while the two other angles ( $60^\circ$ ,  $80^\circ$ ,  $100^\circ$  and  $0^\circ$ ), are taken as arbitrary angles only for the purpose of analyses.

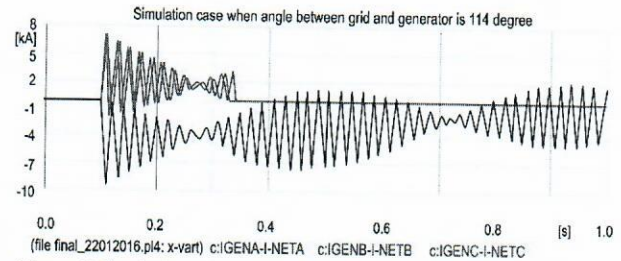

Figure 8 Simulation of Synchronization of generator into power system on wide angle  $114^\circ$

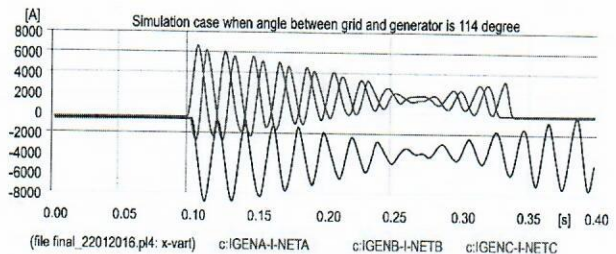

Figure 9 Simulation of synchronization of generator into power system on wide angle  $114^\circ$

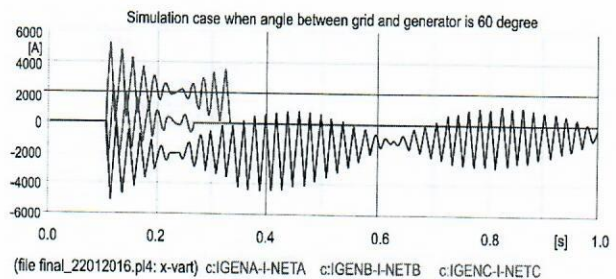

Figure 10 Simulation of synchronization of generator into power system on wide angle  $60^\circ$

Through these simulations it can be seen that depending on the angle in which generator is connected to the network current varies on the particular phases as well as value of DC component. This has impact on the time delay of the AC component crossing through zero.

Similar simulations have been made even in the case of short circuit in order to compare the magnitude of DC



component during the short circuit and asynchronous connection of the generator to the network.

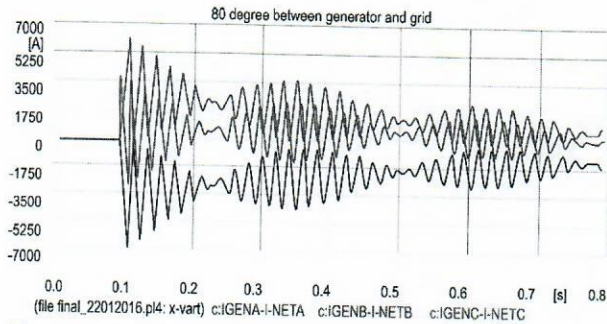

Figure 11 Simulation of synchronization of generator into power system on wide angle 80°

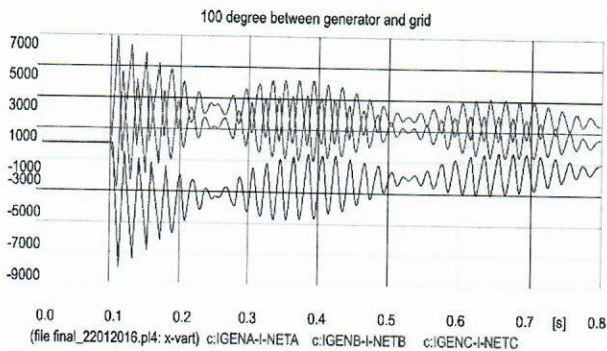

Figure 12 Simulation of synchronization of generator into power system on wide angle 100°

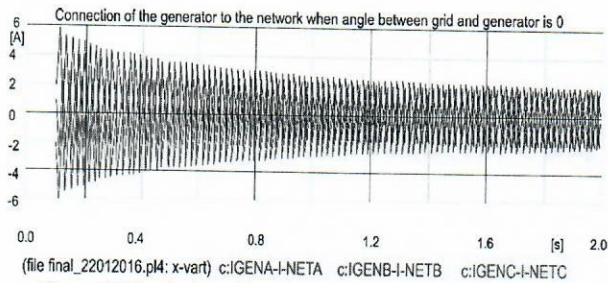

Figure 13 Simulation of Synchronization of generator into power system on wide angle 0°

Table 5 Value of DC component of current during short circuit

PP Kos B 400 kV	Value of DC component of current during short circuit				Value of dc component of current during asynchronous connection of generator to network without meeting the synchronizing condition.	
	S (MVA)	$I$ (A)	$I_{dyn}$ (A)	$I_{DC}$ (A)	$I_{AC}$ (A)	$I_{DC}$ (A)
	15858.4	22890	59618.9	7274.5	2130	3600

An analysis of short circuit near the generator is performed also using PSS/E software and ATP for transient analyses (We have used PSS/E for calculation of short circuit in the network since the model of the system of Kosovo and wider in the region is in PSS/E. In order to simulate the behavior of system during the fault the

equivalent system was calculated with PSS/E. With ATP simulation tools is performed the modeling of only faulted generator during asynchronous connection, unit transformer and circuit breaker connected to equivalent network). Short circuit is simulated on bus bar 400 kV when generator is connected. The results of short circuit current, maximum current (first peak of fault current) and DC component values are presented in Tab. 5.

During faults as result of short circuits, the initial value of DC component is higher than in case of asynchronous closing of the circuit breaker. However, DC component decreases very quickly and this allows for AC component to cross through zero, but in case of the asynchronous connection the time delay of DC component is much higher which in turn causes the effect on the AC component crossing time through zero making it thus higher [16, 17, 18].

### 5 Analyses and Discussion

Circuit-breakers used for generator switching applications are subject to conditions quite different from those of normal circuit-breakers used in utility systems.

Usually in generator AC breaker during the disconnection process, serious problem occurs due to the presence of high value DC component that makes the AC component be delayed passing through zero. It is essential for AC current to pass through zero, namely the arc is extinguished in this point and its restart is more difficult, enabling a successful disconnection. In the abovementioned case, the value of the DC component reached the value of 3.11 kA, whereas the time delay of passing of the AC component through zero was 100 ms. This is very long time for AC circuit breakers that perform the disconnection in less than 50 ms.

Based on the results of performed simulations it can be concluded that the circuit breaker of generator shall be specified to be capable to disconnect the asymmetrical currents caused by short circuit where the DC exceeds the value of 7.3 kA. It is very important to consider also the time delay needed for the DC component to decrease enough in order that overall short circuit current passes through zero. This shall be specified carefully in the new circuit breakers and relay time settings.

### 6 Conclusion

This paper presents analysis of the performance of circuit breaker during disconnection of the failure currents that appear as a result of asynchronous connection of the generator on the grid. The analysis is based on the case of accidental closing of the circuit breaker without synchronization of generator to the network, because of failure on the control circuits of generator circuit breaker. The case is modeled using ATP and PSS/E software and results are compared with values recorded in real time of the voltages and currents.

The case which is analyzed in the paper was connection of the generator to the network by accident under the angle of 114°. In these circumstances the maximum value of asymmetric current is 130 % of the peak value of symmetric in this case. Consequently, AC component of the current has not passed through zero for



time 100 ms. This caused the damage of the SF6 circuit breaker as the circuit breaker was not able to disconnect currents which did not pass through zero.

In the incident reported here, delaying the relay trip order to the high voltage circuit breaker for 70 ms would have been beneficial, allowing the DC component of current to enable current crossing through zero and so sufficient interruption without causing any damage to the circuit breaker.

Following conclusions can be made:

- Specification of generator circuit breakers requires special analyses of transient network processes respectively at connection point.
- The DC component specifically must be analyzed in detail, in order to specify the adequate circuit breaker that is capable to disconnect the current at different faults near the generator.
- Very often the transient disconnections with SF6 and ultra-fast relays are not advantageous for generator circuit breakers. In this case the disconnection delay is in favor of a successful disconnection with AC circuit breaker.
- It is important to study the network for dimensioning of generator breakers for each case particularly.
- Very important to consider is also the time constant needed for the DC component to decrease enough in order that overall short circuit current passes through zero.
- Fast tripping relay protection at generator circuit breakers is not advantage in all practical circumstances.
- If the circuit breaker is installed near power plant, the time constant shall be taken greater hence a circuit breaker will be chosen with higher percentage value of DC component of short circuit current or with higher interrupting capability.

## 7 References

- [1] Kundur, P. Power System Stability and Control, McGraw-Hill, inc. edition 1994, pp. 45-198, pp. 463-577.
- [2] Machowski, J.; Bialek, J. W.; Bumby, J. R. Power System Dynamics and Stability, Jon Wiley & Sons Ltd, second edition 2008, pp. 127-261.
- [3] Garzon, R. D. High Voltage Circuit Breakers, Design and Applications, CRC Press, 2nd edition, 1996, pp 27-40, pp 381-410.
- [4] IEC 62271-100 High-voltage alternating - current circuit-breakers, CEI/IEC 62271-100:2001+A1:2002
- [5] International standard IEC 62271-100, High-voltage alternating-current circuit-breakers, 2003.
- [6] International standard IEC 62271-203, Use and handling of sulphur hexafluoride (SF6) in high-voltage switchgear and controlgear, 2008.
- [7] Kapetanovic, M. High Voltage Circuit Breakers, Sarajevo, 2011, pp. 235-265, pp. 347-413.
- [8] Kapetanovic, M. Visokonaponski prekidaci, Elektrotehnicki fakultet, Sarajevo, BiH, 2002, pp. 170-180.
- [9] Siemens launches world's first 1200 kV SF6 Circuit Breaker. Retrieved 14 November 2011.
- [10] Application guide: Live Tank Circuit Breakers, ABB High Voltage, 2010.
- [11] Ježek, V. Short Circuit Capability of Generator Circuit Breaker, May 2011, Železna Ruda-Špičák, University of

West Bohemia, Czech Republic, Intensive Programme "Renewable Energy Sources", pp. 155-158, May 2011.

- [12] Asymmetry characteristics of progressive short circuit on large synchronous generator is done by R. E. Owen, W. A. Lewis, EHV Conference, Los Angeles, July 12-17. 1970.
- [13] Working Group, B5.04 International Guide on the Protection of Synchronous Generators, October 2011.
- [14] Uglješić, I.; Filipović-Grčić, B.; Bojić, S. Analiza kvara 400 kV SF6 prekidača uslijed isklopa dalekovoda u praznom hodu, HRO CIGRE, Cavtat 2013.
- [15] "Applications of Disconnecting Circuit Breakers, Michael Faxá, p. 1". Retrieved 9 July 2012.
- [16] TPP Kosovo B, SS 400/220 kV, report and recordings from damages of the circuit breaker, 2011.
- [17] KOSTT, Electrical Equipment Code, 2<sup>nd</sup> Edition, 2009, www.kostt.com
- [18] KOSTT, Grid Code, 2008, 2<sup>nd</sup> Edition, 2010, www.kostt.com

### Authors' addresses

**Avni Alidemaj, Eng., Mr. Sc**

Kosovo Electricity Distribution and Supply,  
KEDS, Bill Clinton Boulevard, no. 3  
10000 Prishtina, Kosovo  
Faculty of Electrical and Computer Engineering,  
University of Prishtina, Bregu i Diellit, p.n.  
10000 Prishtina, Kosovo  
avalidemaj@gmail.com

**Sreten Škuletić, Prof. Dr.**

Faculty of Electrical Engineering,  
University of Montenegro,  
Džordža Vašingtona bb, 81000 Podgorica, Montenegro  
skuletic@ac.me

**Vladan Radulović, Doc. Dr.**

Faculty of Electrical Engineering  
University of Montenegro,  
Džordža Vašingtona bb, 81000 Podgorica, Montenegro  
vladanra@ac.me







## Biografija

### Avni Alidemaj

Osnovni podaci	
Rodendan, mjesto i općina.	16.10.1967, S. Kernina, Istog, Kosovo
Pol.	M
Adresa	Ul. Zhujë Selmani, B.B, Peć, Kosovo
Građanski status.	Oženjen, troje djece.
Obrazovanje i akademska zvanja	
<b>2013</b>	Registracija Doktorata u Univerzitetu Crne Gore, Elektrotehnički Fakultet, Podgorica.
	<b>Teza:</b> "Uticaj karakteristika visokonaponskih prekidača sa gasom SF <sub>6</sub> na proces isključenja iz mreže generatora velike snage"
<b>2008</b>	Mr. Sc., Univerzitet u Prištini, Fakultet elektrotehnike i računarske tehnike.
	<b>Teza:</b> "Uticaj korone na vrednost energestkih gubitaka na prenosne mreže 220 kV i 400 kV kao i njen efekat na širenje radio i TV talasa"
<b>1997</b>	Diplomirani inženjer elektrotehnike, Univerzitet u Prištini, Tehnički Fakultet
	<b>Teza:</b> "Negativni i pozitivni efekti fenomena korone u tehnici visokog napona"
Profesionalna karijera	
2010-2015	Asistent, Univerzitet u Prištini, Fakultet elektrotehnike i računarske tehnike.
Decembar 2019-U toku	Vanredni profesor, Sveučilište Obrazovanje za poslovno-tehnološka (UBT), Priština.
14 Mart 2019 U toku	Izvršni savjetnik, KEDS
27 Mart 2017 - 14 Marta 2019	Direktor za saradnju sa vladinim institucijama i kontrolu investicija, KEDS
Mart 2014-27 Marta 2017	Direktor za Operacije i Održavanje Mreže, KEDS
Januar 2013 - Maj 2013	V.D. Generalni Direktor, KEDS_a
Juni 2008 - Mart 2014	Ekzekutivni Direktor Distribucije, KEK sh.a/KEDS
08. Mart 2006 - Juni 2008	Menadžer odseka za razvoj mreže, KEK sh.a.
2003 - 08. March 2006	Inženjer za planiranje i razvoj mreže, KEK sh.a.
2002-2003	Odgovorni inženjer Energetike, KEK sh.a.
15.09.1999-2002	Inženjer za nova priključenja, KEK sh.a.



<b>Dužnosti na fakultetu</b>	
2010-2015  Decembar 2019-U toku	Asistent, Univerzitet u Prištini, Fakultet elektrotehnike i računarske tehnike. Vanredni profesor, Sveučilište Obrazovanje za poslovno-tehnološka (UBT), Priština.
<b>Održani / održavaju predmeti na fakultetu</b>	
2010-2015  Decembar 2019-U toku	<ol style="list-style-type: none"> <li>1. Elektrotehnički materijali</li> <li>2. Tehnika visokog napona</li> <li>3. Prenaponi i koordinacija izolacije</li> </ol> <ol style="list-style-type: none"> <li>1. Sustav prijenosa i distribucije / Menadžment inženjeringa</li> <li>2. Energetska elektronika u pametnim mrežama</li> <li>3. Tehnike mjerenja</li> <li>4. Proizvodnja energije vjetra</li> <li>5. Primenjeni projekat</li> </ol>
<b>Treninzi</b>	
	<ul style="list-style-type: none"> <li>• Supervisory skills USAID</li> <li>• Managing Planning USAID</li> <li>• Overall Managing USAID</li> <li>• Distribution Network Modelling Power flow calculation - GREDOSI Software, Pristina.</li> <li>• Energy Measurement and Management, Iskraemeco-Kranj, Slovenia, 2007.</li> <li>• Time Management, MDA, Pristina.</li> <li>• Management Training Program USAID</li> <li>• ArcGIS-basics beak Consultants</li> <li>• Public Procurement, MDA, Pristina</li> <li>• Decisions Making, MDA, Pristina</li> <li>• Public Relations, MDA, Pristina</li> <li>• Dig SILENT Power Factory Basic Training, Pristina</li> <li>• Security Management in KEK, Pristine</li> <li>• Megger Training Centre, High and Low Voltage test equipment at Megger Limited, Dover Kent, and England.</li> <li>• Training regarding Software "EPLAN Electric P8, FIEK, Pristina. <ul style="list-style-type: none"> <li>• MODERN AND SUSTAINABLE WATER AND ENERGY MANAGEMENT, International Visitor Leadership Program from 10 – 28, 2015, USA.</li> </ul> </li> </ul>
<b>Jezici</b>	
	Albanski – materni jezik
	Engleski – dobro
	Crno Gorski, Serpski, Hrvatski, Bosanski – vrlo dobro

Priština, Kosovo  
17.07.2020

Mr. Sc. Avni Alidemaj, PhD Candidate





## Bibliografija

### Avni Alidemaj

Osnovni podaci	
Rodendan, mjesto i općina.	16.10.1967, S. Kernina, Istog, Kosovo
Pol.	M
Adresa	Ul. Zhujë Selmani, B.B, Peć, Kosovo
Gradanski status.	Oženjen, troje djece.
Obrazovanje i akademska zvanja	
<b>2013</b>	Registracija Doktorata u Univerzitetu Crne Gore, Elektrotehnički Fakultet, Podgorica.
	<b>Teza:</b> "Uticaj karakteristika visokonaponskih prekidača sa gasom SF <sub>6</sub> na proces isključenja iz mreže generatora velike snage"
<b>2008</b>	Mr. Sc., Univerzitet u Prištini, Fakultet elektrotehnike i računarske tehnike.
	<b>Teza:</b> "Uticaj korone na vrednost energestkih gubitaka na prenosne mreže 220 kV i 400 kV kao i njen efekat na širenje radio i TV talasa"
<b>1997</b>	Diplomirani inženjer elektrotehnike, Univerzitet u Prištini, Tehnički Fakultet
	<b>Teza:</b> "Negativni i pozitivni efekti fenomena korone u tehnici visokog napona"
Profesionalna karijera	
2010-2015	Asistent, Univerzitet u Prištini, Fakultet elektrotehnike i računarske tehnike.
Decembar 2019-U toku	Vanredni profesor, Sveučilište Obrazovanje za poslovno-tehnološka (UBT), Priština.
14 Mart 2019 U toku	Izvršni savjetnik, KEDS
27 Mart 2017 - 14 Marta 2019	Direktor za saradnju sa vladinim institucijama i kontrolu investicija, KEDS
Mart 2014-27 Marta 2017	Direktor za Operacije i Održavanje Mreže, KEDS
Januar 2013 - Maj 2013	V.D. Generalni Direktor, KEDS_a
Juni 2008 - Mart 2014	Ekzekutivni Direktor Distribucije, KEK sh.a/KEDS
08. Mart 2006 - Juni 2008	Menadžer odseka za razvoj mreže, KEK sh.a.
2003 - 08. March 2006	Inženjer za planiranje i razvoj mreže, KEK sh.a.
2002-2003	Odgovorni inženjer Energetike, KEK sh.a.
15.09.1999- 2002	Inženjer za nova priključenja, KEK sh.a.



<b>Dužnosti na fakultetu</b>			
2010-2015	Asistent, Univerzitet u Prištini, Fakultet elektrotehnike i računarske tehnike.		
Decembar 2019-U toku	Vanredni profesor, Sveučilište Obrazovanje za poslovno-tehnološka (UBT), Priština.		
<b>Održani / održavaju predmeti na fakultetu</b>			
2010-2015	<ol style="list-style-type: none"> <li>1. Elektrotehnički materijali</li> <li>2. Tehnika visokog napona</li> <li>3. Prenaponi i koordinacija izolacije</li> </ol>		
Decembar 2019-U toku	<ol style="list-style-type: none"> <li>1. Sustav prijenosa i distribucije / Menadžment inženjeringa</li> <li>2. Energetska elektronika u pametnim mrežama</li> <li>3. Tehnike mjerenja</li> <li>4. Proizvodnja energije vjetra</li> <li>5. Primenjeni projekat</li> </ol>		
<b>Naučna objavljivanja</b>		<b>Impact Factor</b>	<b>Cituar</b>
1.	<p><b>“Efficiency of Electrostatic Precipitators at Kosova ‘B’ PP”</b></p> <p><b>Objavljeno u:</b> “Balkan Power Conference”, Šibenik, Hrvatska. 2008.</p> <p><b>Autori:</b> Isuf Krasniqi, Avni Alidemaj</p>		
2.	<p><b>“ Efekti korone i njena uloga ”</b></p> <p><b>Objavljeno u:</b> casopisu KERKIME, br 17-Akademia Nauke i Umetnosti Kosova, Priština, 2009.</p> <p><b>Autori:</b> Isuf Krasniqi, Avni Alidemaj</p>		
3.	<p><b>“Increase Power Transfer Capability And Controlling Line Power Flow In Power System Installed The FACTS”</b></p> <p><b>Objavljeno u:</b> “Mediteran MedPower 2010”, Cipar, Novembar 2010.</p> <p><b>Autori:</b> Vjollca Komoni, Isuf Krasniqi, Gazmend Kabashi, Avni Alidemaj</p>		1
4.	<p><b>“Corona Losses Dependence From The Conductor Diameter”</b></p> <p><b>Objavljeno u:</b> WSEAS Conferences, 3-5 Oktobar, 2011, Malajzia.</p> <p><b>Autori:</b> Isuf Krasniqi, Vjollca Komoni, Avni Alidemaj, Gazmend Kabashi</p>		2



5.	<p align="center"><b>“Sučnano osvetljenje u Štimlje”</b></p> <p><b>Objavljeno u:</b> Nacionalna Konferencija, Politehnički Univerzitet, <b>Tirana, Albanija</b>, Oktobar, 2011.</p> <p><b>Autori:</b> Vehbi Sofiu, Isuf Krasniqi, Zamir Dika, <b>Avni Alidemaj</b></p>		
6.	<p align="center"><b>“Procenjivanje električnih gubitaka u mreži distribucije kao i mere koje treba preduzeti da bi se oni smanjili”</b></p> <p><b>Objavljeno u:</b> Konferenca kombëtare, Politehnički Univerzitet, <b>Tirana, Albanija</b>, Oktobar, 2011.</p> <p><b>Autori:</b> Vjollca Komoni, Arben Gjukaj, <b>Avni Alidemaj</b>, Lutfije Dervishi.</p>		
7.	<p align="center"><b>“Control Active and Reactive Power Flow With UPFC Connected in Transmission Line”</b></p> <p><b>Objavljeno u:</b> 8<sup>th</sup> Mediterranean Conference on Power Generation, Transmission, Distribution and Energy, <b>Cagliari, Italy</b>, 10/2012.</p> <p><b>Autori:</b> V. Komoni, I. Krasniqi, Gazmend Kabashi, <b>A. Alidemaj</b></p>		8
8.	<p align="center"><b>“Improve energy losses and quality of electricity in low voltage network in Kosova”</b></p> <p><b>Objavljeno u:</b> The 5th International Conference &amp; Workshop, <b>Remo, Budva</b>, Montenegro, 23-24.09.2015.</p> <p><b>Autori:</b> L. Dervishi, M. Koc, <b>A. Alidemaj</b>, A. Ymeri</p>		
9.	<p align="center"><b>“Impact of Time Relay for Changing of the Tariff on Commercial Losses at Mechanical Meters”</b></p> <p><b>Objavljeno u:</b> IFAC International Conference on International Stability, Technology and Culture, (<b>TECIS</b>), 26-28 Oktobar 2016, <b>Durres, Albanija</b>.</p> <p><b>Autori:</b> <b>Avni ALIDEMAJ</b>, Vehbi SOFIU, Lutfije DERVISHI, Arif VITIJA, Sadik LATIFAJ</p>		



10.	<p><b>“Application of Complementary Machine-Complex”</b></p> <p><b>Objavljeno u:</b> IFAC International Conference on International Stability, Technology and Culture, (TECIS), 26-28 Oktobar 2016, Durres, Albanija.</p> <p><b>Autori:</b> Vehbi SOFIU Avni ALIDEMAJ</p>		1
11.	<p><b>“Fault current due to asynchronous connection of the generator to the grid and impact on HV circuit breaker with gas SF6”</b></p> <p><b>Objavljeno u:</b> Tehnički Vjesnik, Technical Gazette, December 2017, Slavonski Brod, Hrvatska.</p> <p><b>Authors:</b> Avni ALIDEMAJ, Sreten Škuletić, Vladan Radulović</p>	0.64	6
12.	<p><b>“Production, distribution and supply of electricity in Kosovo for the period 2000-2015”</b></p> <p><b>Objavljeno u:</b> International Journal of Civil Engineering and Technology, IAEME Publication (IJCIET), Tamilnadu, India, 06. April. 2018.</p> <p><b>Autori:</b> Avni ALIDEMAJ, Ahmet Shala</p>		
13.	<p><b>“Interruptions in the electricity distribution system”</b></p> <p><b>Objavljeno u:</b> CIGRE, SEERC, KIEV, UKRAINE, June 12-13. 2018.</p> <p><b>Autori:</b> Avni ALIDEMAJ, Sadik LATIFAJ, Arben SALIHU, Shukri ALIU</p>		
14.	<p><b>“Dissolved gas analysis (DGA) method application in power transformer maintenance”</b></p> <p><b>Objavljeno u:</b> CIGRE, SEERC, KIEV, UKRAINE, June 12-13. 2018.</p> <p><b>Autori:</b> Kjani GURI, Avni ALIDEMAJ</p>		



15.	<p><b>“Internal defects of the medium voltage circuit breaker”</b></p> <p>Objavljeno u: CIGRE, SEERC, Priština, Kosovo, 06-08 November 2018.</p> <p>Autori: Avni ALIDEMAJ, Arif VITIJA, Nezir NEZIRI, Naser XHAMBAZI</p>		
16.	<p><b>“Advantages and disadvantages of the underground network and respecting the rules during aligning medium voltage cables”</b></p> <p>Objavljeno u: CIGRE, SEERC, Priština, Kosovo, 06-08 November 2018.</p> <p>Autori: Avni ALIDEMAJ, Sadik LATIFAJ, Qendrim NIKA, Kujtim MIFTARI</p>		
17.	<p><b>“The benefits for switching from overhead lines (OHL) to underground cable lines”</b></p> <p>Objavljeno u: CIGRE, SEERC, Priština, Kosovo, 06-08 November 2018.</p> <p>Autori: Avni ALIDEMAJ, Edita BYTYQI, Enis RIZA</p>		
18.	<p><b>“Important Factors for Consideration during the Specification of SF6 Circuit Breakers for High Voltage Generators”</b></p> <p>Objavljeno u: MDPI-Energies, Basel, Switzerland, July 2020</p> <p>Autori: Avni ALIDEMAJ, Qendrim NIKA</p>	2.702	
<b>Članstvo u organizacije i profesionalne akademije</b>			
Od 2010	Član Tehničkog Komiteta za Standarde u Elektrotehnici, Kosovo, MTI.		
Od 2015	Član IEEE		
Od 2017	Član CIGRE-a, Nacionalnog komiteta Kosova.		
<b>Treninzi</b>			
	<ul style="list-style-type: none"> <li>• Supervisory skills                      USAID</li> <li>• Managing Planning                      USAID</li> <li>• Overall Managing                      USAID</li> <li>• Distribution Network Modelling Power flow calculation - GREDOSI Software, Pristina.</li> <li>• Energy Measurement and Management, Iskraemeco-Kranj,</li> </ul>		



	<p>Slovenia, 2007.</p> <ul style="list-style-type: none"> <li>• Time Management, MDA, Pristina.</li> <li>• Management Training Program USAID</li> <li>• ArcGIS-basics beak Consultants</li> <li>• Public Procurement, MDA, Pristina</li> <li>• Decisions Making, MDA, Pristina</li> <li>• Public Relations, MDA, Pristina</li> <li>• Dig SILENT Power Factory Basic Training, Pristina</li> <li>• Security Management in KEK, Pristine</li> <li>• Megger Training Centre, High and Low Voltage test equipment at Megger Limited, Dover Kent, and England.</li> <li>• Training regarding Software "EPLAN Electric P8, FIEK, Pristina.</li> <li>• MODERN AND SUSTAINABLE WATER AND ENERGY MANAGEMENT, International Visitor Leadership Program from 10 – 28, 2015, USA.</li> </ul>
<b>Jezici</b>	
	Albanski – materni jezik
	Engleski – dobro
	Crno Gorski, Serpski, Hrvatski, Bosanski – vrlo dobro

Priština, Kosovo

17.07.2020

Mr. Sc. Avni Alidemaj, PhD Candidate

## **Prof. dr Vladan Radulović** **- Biografija -**

Radulović Vladan je rođen 27.08.1979. godine u Podgorici. Na Elektrotehnički fakultet u Podgorici, odsjek energetika, upisao se 1998. godine. Diplomirao je 01.11.2002. godine odbranom diplomskog rada "Sklopni prenaponi" sa ocjenom 10 i prosječnom ocjenom tokom studija 9,79.

Na poslijediplomske studije na Elektrotehničkom fakultetu u Podgorici, smjer elektroenergetski sistemi, upisao se 2002. godine i iste završio sa prosječnom ocjenom 10. Magistarsku tezu pod nazivom „Izbor odvodnika prenapona sa aspekta uticaja privremenih prenapona u elektroenergetskom sistemu“ je odbranio 06.06.2005. godine na Elektrotehničkom fakultetu u Podgorici.

Doktorsku disertaciju pod nazivom: „Optimizacija sistema zaštite od atmosferskog pražnjenja u električnim instalacijama niskog napona“ odbranio je 08.03.2011. godine na Elektrotehničkom fakultetu u Podgorici.

U zvanje docenta na Elektrotehničkom fakultetu izabran je u novembru 2011. godine, a u zvanje vanrednog profesora u januaru 2017 godine.

Autor je više naučnih i stručnih radova u renomiranim međunarodnim i domaćim časopisima i konferencijama. Član je više međunarodnih i domaćih organizacija i udruženja. Recenzent je u više renomiranih međunarodnih časopisa.

Oblasti stručnog interesovanja su: elektrane, alternativni izvori električne energije, prenaponska zaštita, tehnika visokog napona, visokonaponska razvodna postrojenja, modelovanje elemenata elektroenergetskih sistema.

Kontakt informacije:

Prof. dr Vladan Radulović

Univerzitet Crne Gore, Elektrotehnički fakultet  
Bulevar Džordža Vašingtona bb  
81000 Podgorica, Crna Gora  
Mob. tel. +382 69 537 605  
e-mail: [vladanra@ucg.ac.me](mailto:vladanra@ucg.ac.me)



**Prof. dr Vladan Radulović**  
**Izvod iz bibliografije - Spisak najznačajnih referenci**

1. **V. Radulović**, S. Škuletić (2011): „Influence of Combination Wave Generator’s Current Undershoot on Overvoltage Protective Characteristics“, IEEE Transactions on Power Delivery, 2011, Vol. 26, Issue 1, pp. 152–160, ISSN: 0885-8977, DOI: 10.1109/TPWRD.2010.2060501
2. Katić V., Mujović S., **Radulović V.**, Radović J (2011): „The Impact of the Load Side Parameters on PC Cluster's Harmonics Emission“, Advances in Electrical and Computer Engineering, 2011, Vol. 11, Broj 1, pp. 103-110, ISSN 1582-7445, DOI: 10.4316/AECE.2011.01017
3. Mujović S., Đukanović S., **Radulović V.**, Katić V. A., Rašović M. (2013): “Least Squares Modeling of Voltage Harmonic Distortion Due to PC Cluster Operation”, Advances in Electrical and Computer Engineering, 2013, Vol. 13, Issue 4: 133-138, ISSN 1582-7445, DOI: DOI: 10.4316/AECE.2013.04022
4. **Radulović V.**, Mujović S., Miljanić Z. (2015): “Characteristics of Overvoltage Protection with Cascade Application of Surge Protective Devices in Low-Voltage AC Power Circuits”, Advances in Electrical and Computer Engineering, 2015, Vol. 15, Issue 3: 153-160, ISSN 1582-7445, DOI: 10.4316/AECE.2015.03022
5. Mujović S., Đukanović S., **Radulović V.**, Katić V. A. (2016): “Multi-Parameter Mathematical Model for Determination of PC Cluster Total Harmonic Distortion Input Current”, COMPEL: The International Journal for Computation and Mathematics in Electrical and Electronic Engineering, 2016, Vol. 35 No. 1: 305-325, ISSN 0332-1649, DOI: 10.1108/COMPEL-03-2015-0149.
6. **Radulović V.**, Miljanić Z. (2016): “The Requirements for Efficient Overvoltage Protection of Electronic Devices in Low-Voltage Power Systems”. Tehnički vjesnik Technical Gazette Vol. 24, No. 6, pp. 1813-1819, 2017DOI: 10.17559/TV-20160128145656
7. **V. Radulović**, S. Mujović , Z. Miljanić (2017): „Effects of Different Combination Wave Generator Design on Surge Protective Devices Characteristics in Cascade Protection Systems“, IEEE Transactions on Electromagnetic Compatibility, Vol. 59, Issue 3, pp. 823 – 834, 2017 DOI: 10.1109/TEMPC.2016.2632752
8. Z. Miljanić, **V. Radulović**, B. Lutovac (2018): „Efficient Placement of Electric Vehicles Charging Stations using Integer Linear Programming“, Advances in Electrical and Computer Engineering, Vol. 2, No. 2, pp. 11-16, 2018, DOI: 10.4316/AECE.2018.02002
9. **V. Radulović**, S. Mujović (2019): „Coordination of surge protective devices in low voltage AC power installations“, SN Applied Sciences, S. SN Appl. Sci. (2019) 1, 2019.



Univerzitet Crne Gore  
adresa: address\_Cetinska br. 2  
81000 Podgorica, Crna Gora  
telefon: phone\_00382 20 414 255  
fax: 00382 20 414 230  
mail: rektorat@ucg.me  
web: www.ucg.ac.me  
*University of Montenegro*

Broj / Ref 03-80  
Datum / Date 12.01. 2017

Na osnovu člana 72 stav 2 Zakona o visokom obrazovanju („Službeni list Crne Gore“ br. 44/14, 47/15,40/16) i člana 32 stav 1 tačka 9 Statuta Univerziteta Crne Gore, Senat Univerziteta Crne Gore na sjednici održanoj 12.januara 2017.godine, donio je

### ODLUKU O IZBORU U ZVANJE

Dr Vladan Radulović bira se u akademsko zvanje vanredni profesor Univerziteta Crne Gore za oblast Elektroenergetika na Elektrotehničkom fakultetu, na period od pet godina.

  
**REKTOR**  
Prof. Radmila Vojvodić

Crna Gora  
UNIVERZITET CRNE GORE  
ELEKTROTEHNIČKI FAKULTET

Primljeno: <u>12.01.2017</u>			
O.g. jed.	Broj	Prilog	Vrijednost
<u>02/1</u>	<u>56</u>		



## Prof. dr SRETEN ŠKULETIĆ, FIET

### Kratka biografija

Sreten Škuletić je rođen 24. juna 1949. godine u Nikšiću, Crna Gora. Diplomirao je 1972. g. na Elektrotehničkom fakultetu u Titogradu, magistrirao 1975.g. na ETF-u u Beogradu, doktorirao 1981.g. na ETF-u Titogradu.

Odmah nakon diplomiranja, 1972.g. zaposlio se na Katedri za Energetiku Elektrotehničkog fakulteta u Titogradu, gdje je, u redovnoj proceduri, prošao sva asistentska i nastavnička zvanja, da bi 1992. bio izabran za redovnog profesora (najmlađi do tada izabrani redovni profesor na Univerzitetu).

Kao najbolji student Fakulteta dobio je Studentsku nagradu „19 DECEMBAR“ 1971.godine, a kao priznanje za postignute rezultate, dobio je NAGRADU OSLOBOĐENJA PODGORICE za 1998.godinu. Za ostvarene rezultate dobitnik je više stručnih i naučnih priznanja i nagrada.

Do sada je, sam ili u saradnji sa drugim autorima uradio i objavio 268 referenci, od čega 123 na našem jeziku, 144 na engleskom jeziku, i jednu na slovenačkom jeziku. Takođe je napisao i objavio univerzitetski udžbenik za predmet "Tehnika visokog napona" (1989.g., 245 strana) i "Praktikum za laboratorijske vježbe iz Tehnike visokog napona" (2004.g., 61 strana) i za predmet Elektrane (2007.g., 375 strana), a u završnoj fazi su i udžbenici za predmete: "Osnove elektroenergetike" i „Visokonaponska razvodna postrojenja“.

Jedan je od autora, odgovornih urednika ili priređivača više monografija i izdanja: "Univerzitet Crne Gore" (na našem jeziku i skraćena verzija na engleskom jeziku), "35 godina studija elektrotehnike u Crnoj Gori", "25 godina Univerziteta Crne Gore", "Elektrotehnički fakultet - 40 godina studija", "Elektrotehnički fakultet - 50 godina razvoja", "Dokumenti Univerziteta", "Prospectus of University", "Strategija naučnoistraživačkog razvoja Crne Gore 2008.-2016." i sl.

Osnovni naučno-istraživački interes mu je u oblasti Elektroenergetskih sistema, naročito u oblastima: Modelovanje, procjene i proračuni pouzdanosti elektroenergetskih sistema - koncept, modeli, proračunske tehnike i primjena; Pouzdanost proizvodnje, prenosa i napajanja električnom energijom; Proračuni i analize pouzdanosti i u složenim šemama elektroenergetskih sistema; Energetika; Elektrane, Problemi u elektranama i visokonaponskim postrojenjima; Visokonaponski problemi u elektroenergetskim sistemima; Uzemljenja; Racionalno korišćenje energije; Konvencionalni i novi izvori energije (obnovljivi izvori, naročito solarna energija i energija vjetra),...

Kao rukovodilac, koordinator ili član tima učestvovao u izradi više domaćih i međunarodnih naučno-istraživačkih projekata (USA - Washington University in St. Louis; USA - Texas A&M University; USA - George Mason University, Washington, Italy - University in Bari; Italy - Politecnico di Bari, Italy — University in Lecce; Velika Britanija - UMIST Manchester; Evropska Unija (EU, EC i CoE); Zajednica Mediteranskih Univerziteta (CMU); Njemačka - DAAD; Njemačka - University Erlangen-Nurnberg; China - North China Electric Power University - Peking; Italy - ISUFI - Istituto Superiore Universitario per la Formazione Interdisciplinare - Lecce; EU Tempus; EU ETF; EU INTERREG; UNESCO; HP; OECD; UNDP; CEI; CEEPES; Socrates; Leonardo; Erasmus Mundus, External Cooperation Windows, SEEGRID; SEE ERANET; WUS Austria; Belgija; Grčka; Švedska; Litvanija ...).

U toku dosadašnjeg naučno-istraživačkog rada učestvovao na različite načine u radu više ekspertskih, naučnih i stručnih timova i komisija, radeći na rješavanju svakodnevnih ili iznenadnih tehničkih praktičnih problema.

Neke od važnijih administrativnih aktivnosti koje je do sada obavljao: Ministar prosvjete i nauke u Vladi Crne Gore, Prorektor Univerziteta za nastavu, Prorektor Univerziteta za nauku, Prorektor Univerziteta za međunarodnu i međuuniverzitetsku saradnju, član Senata i Vijeća Univerziteta, Predsjednik Savjeta Informacionog Sistema Univerziteta, Predsjednik Paritetne komisije za naučno-nastavnu saradnju Univerziteta Crne Gore i Univerziteta Regije Pulja, član Savjeta za nauku i tehnološki razvoj Ministarstva prosvjete i nauke Republike Crne Gore, član Pedagoškog Savjeta Ministarstva prosvjete i nauke RCG, član Koordinacionog odbora Vlade RCG za podsticanje, praćenje i koordiniranje aktivnosti na pripremama i izgradnji novih elektroenergetskih objekata u CG, Koordinator na projektima: "Informacioni sistem UCG" i „Akademska mreža SRJ“, član Komisije za Akademi Internet Saveznog Ministarstva za razvoj, nauku i životnu sredinu, Podpredsjednik Zajednice Mediteranskih Univerziteta, Koordinator MREN-a (Nacionalne istraživačke akademske elektronske mreže), član Vijeća za prirodne i tehničke nauke SENATA UCG, član Uređivačkog odbora Univerzitetskih publikacija - Urednik biblioteke tehničkih i primijenjenih nauka, član Savjeta za naučnoistraživačku djelatnost Vlade CG,...Dekan Elektrotehničkog fakulteta, Predsjednik Savjeta Fakulteta, Prodekan za nastavu Fakulteta, Šef Katedre za postrojenja električne snage, Rukovodilac Laboratorije za visoki napon,...

U dosadašnjem radu bio veoma aktivno uključen u više domaćih i inostranih stručnih i naučnih udruženja i asocijacija, kao rukovodilac ili njihov aktivni član. Dio najznačajnijih od njih:



Član (Full Member) International Academy of Electrotechnical Sciences, Moscow, Russia, FELLOW of IEE (sada IET) - najviše profesionalno zvanje Međunarodnog Instituta Elektro Inženjera IEE London (sada The Institution of Engineering and Technology), UK, član profesionalnih IEE grupa iz oblasti elektroenergetike: P7 - Prenosna i Distributivna postrojenja; P8 - Vazdušni vodovi i Kablovi i P9 - Planiranje i rad elektroenergetskih sistema, Ekspert Saveznog ministarstva znanauku, tehnologiju i razvoj u oblasti: 1227 Elektroenergetski sistemi (pouzdanost, tehnika visokog napona, proizvodnja električne energije, uzemljenje) i 1554 Novi izvori energije, član Komisije za tehničke nauke Crnogorske Akademije nauka i umjetnosti, zamjenik predsjednika Savjeta Saveznog ministarstva za privredu, za razvoj energetike SRJ, član Skupštine i Izvršnog odbora jugoslovenskog nacionalnog komiteta CIRED-a i predsjednik Stručne komisije (STK) 3- Distributivni energetske vodovi, član Studijskih komiteta (SK) 33 i 37 JUKO CIGRE, član Naučnog Komiteta međunarodne AMSE konferencije, "Signals, Data & Systems" za oblast elektrotehnika i elektronika, član Upravnog odbora JEP EPCG, predsjednik Skupštine EPCG, podpredsjednik Nacionalnog Savjeta za promjene u obrazovanju u CG, član Nacionalnog Savjeta za promjene nastavnih planova i programa i predsjednik Komisije za Stručno obrazovanje, Nacionalni Koordinator za saradnju sa UNESCO-om, član Nacionalne Komisije Srbije i CG za saradnju sa UNESC-om i član odbora za prosvjetu Komisije Srbije i CG za saradnju sa UNESCO-om, član CIRED Međunarodnog Programskog Komiteta za Regionalne CIRED Konferencije, član WSEAS (World Scientific and Engineering Academy and Society) za Elektroenergetske sisteme, radio u Peer Review Teem-ovima, koji su organizovani od strane EU, OECD i Stability Pact for South Eastern Europe sa zadatkom analize obrazovnog sistema i politike obrazovanja u Albaniji i BiH, član EU MOCO WBC - Monitoring Komiteta EU za naučno-istraživački rad u zemljama Zapadnog Balkana (EU Monitoring Committee for RTD-Cooperation with the Western Balkan Countries - sada Steering Platform), član Upravnog Odbora (Governing Board) Evropske Asocijacije za Male Hidroelektrane (ESHA - European Small Hydropower Association), koja radi pod okriljem EREC i Evropske Komisije u Briselu, ...

Nalazi se na rosteru međunarodnih eksperata tri organizacije UN: Agencije za tehničku saradnju za razvoj (UN DTCD), Agencije za industrijski razvoj (UNIDO) i UNESCO-a.

Školske 1982/83. godine, kao stipendista Fulbrajtovog programa, u svojstvu Viziting profesora, boravio je na Systems Science and Mathematics Department, Washington University in St. Louis, Missouri, USA.

Od 1. oktobra 1990. godine do 31. septembra 1991. godine proveo na Univerzitetu u Manchesteru (UMIST) radeći kao rukovodilac na naučno-istraživačkom projektu pod nazivom: „Reliability Assesment of Composite Systems“. Nakon toga u više navrata boravio po nekoliko nedjelja na UMIST-u.

Koristeći stipendiju za Istaknute istraživače (Award for Outstanding Senior Researchers for the Study and Research Visit in the Fedrela Republic of Germany) dobijenu od DAAD (German Academic Exchange Service) dva puta po mjesec dana (2000. i 2003.) proveo na Friedrich-Alexander University Erlangen-Nurnberg.

Kao UN Ekspert u oblasti Energetike od Evropske Komisije, Generalni Direktorat za Energiju, po pozivu kao predavač učestvovao na Workshop-u, koji je u okviru Programa ENERGIE pod nazivom "New and Improved Small Hydropower Technologies for the Balkan Peninsula Market" održan u Atini (Grčka).

Bio je član Istraživačkog tima EU za Altener Research Programme (ECC-Contract: N.4.1030/Z/99-253) " BlueAGE - Blue Energy for a Green Europe.

Na poziv North China Electric Power University iz Pekinga, NR Kina, u vremenu od 15. do 20. aprila 2000. godine organizovao dva seminara za postdiplomce i profesore sa Univerziteta, kao i dva predavanja za studente Elektroenergetskog Odsjeka, iz oblasti tehnike visokog napona i savremenih i novih trendova u ovoj oblasti.

Kao Gost - Profesor učestvovao u pripremi, organizaciji i održavanju kursa iz "Electrical Energy Generation and Distribution", koji je u okviru Summer Academy u organizaciji DAAD, SIEMENS-a i Univerziteta u Erlangenu, a pod pokroviteljstvom Pakta Stabilnosti za Jugoistočnu Evropu održan u Ohridu 2000. godine, a kasnije kao organizator u ime Univerziteta Crne Gore, od 2001 do 2005. godine u Petrovcu, i od 2006. do 2007. g. u Budvi.

U okviru programa International Visitor Leadership Project, u organizaciji US Department of State i Bureau of Educational and Cultural Affairs, boravio u USA u avgustu 2004. godine. Cilj projekta je bio produbljivanje znanja u oblastima: zaštita prirodnih izvora i razvoj alternativnih i obnovljivih izvora energije. Kao rezultat ove posjete potpisan je Sporazum o saradnji Univerziteta u Davisu, Kalifornija i Univerziteta Crne Gore, čiji je bio koordinator.

Govori, čita i piše: engleski, francuski i italijanski, a služi se i ruskim jezikom.



**Prof. dr SRETEN ŠKULETIĆ, FIET**  
- Spisak najznačajnijih referenci iz oblasti -

1. **S. Škuletić**; V. Radulović; I. Stešević: "Possibilities and limitations of measuring the energy of direct solar radiation", Power Engineering, Fourth International Conference on Energy and Electrical Drives (POWERENG), 2013, pp.: 1789 - 1794, DOI: 10.1109/PowerEng.2013.6635889
2. V. Radulović and **S. Škuletić**, "Influence of Combination Wave Generator's current undershoot on Overvoltage protective characteristics," *IEEE Trans. Power Delivery*, vol. 26, no. 1, pp. 152-160, 2011. DOI: 10.1109/TPWRD.2010.2060501
3. **S. Škuletić** and V. Radulović, "Analysis of Surge Protection Performance in low-voltage AC systems with capacitive load," in *45th International Universities Power Engineering Conference, UPEC 2010*, 2010.
4. **S. Škuletić** and V. Radulović, "Effective Protection Distance from Cascade coordinated Surge Protective Devices to Equipment in Low-voltage AC Power Circuits," in *43rd International Universities Power Engineering Conference UPEC, 2008*. [Online]. Available: <http://dx.doi.org/10.1109/UPEC.2008.4651618> .
5. M. Vukasović; **S. Škuletić**:" Implementation of different methods for PTDF matrix calculation in flow-based coordinated auction", International Conference on Power Engineering, Energy and Electrical Drives, 2007, pp: 791 - 795, DOI: 10.1109/POWERENG.2007.4380158
6. **S. Škuletić**; M. Savić; V. Radulović: "Possibility of computer application for calculations of switching overvoltages originated by capacitive current's tripping", 42nd International Universities Power Engineering Conference, 2007. UPEC 2007., pp: 504 - 508, DOI: 10.1109/UPEC.2007.4468999
7. **S. Škuletić**; V. Radulović: "Contribution to Calculation of Switching Overvoltages Originated by Line Energizing in the Networks with Lumped Parameters", Proceedings of the 41st International Universities Power Engineering Conference, 2006 Volume: 3, pp: 926 - 930, DOI: 10.1109/UPEC.2006.367615
8. **S. Škuletić**; A. Balota: "Reliability assessment of composite power systems", Canadian Conference on Electrical and Computer Engineering, 2005. pp: 1718 - 1721, DOI: 10.1109/CCECE.2005.1557314
9. **S. Škuletić**; V. Radulović: "Possibility for fast and easy calculations and analysis of switching overvoltages", 39<sup>th</sup> International Universities Power Engineering Conference, 2004. UPEC 2004., Vol. 1, pp: 149 - 153
10. **S. Škuletić**; P. Mijajlović: "Experimental investigations of switching overvoltages in 110 kV network of power system of Montenegro", Power Tech Conference Proceedings, 2003, IEEE Bologna, Volume: 2, Page: 7, DOI: 10.1109/PTC.2003.1304290

**Podaci o radovima koji su evidentirani u SCOPUS bazi dati su u prilogu.**



## Scopus Preview

Scopus SciVal Register Login Help

This is a preview of SCOPUS.

Click here to learn more about accessing SCOPUS with our Integration Services. Visit also our SCOPUS Info Site.

The Scopus Author Identifier assigns a unique number to groups of documents written by the same author via an algorithm that matches authorship based on a certain criteria. If a document cannot be confidently matched with an author identifier, it is grouped separately. In this case, you may see more than 1 entry for the same author.

Print | E-mail

## Škuletić, Sreten D.

University of Montenegro, Faculty of Electrical Engineering, Podgorica, Montenegro

Author ID: 6602688521

About Scopus Author Identifier | View potential author matches

Other name formats: Škuletić, Sreten  
Skuletic  
Škuletić  
View More

Follow this Author Receive emails when this author publishes new articles

Get citation alerts

Add to ORCID

Request author detail corrections

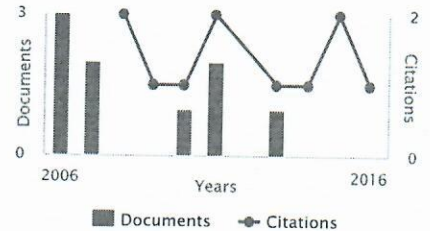

Documents: 28	Analyze author output
Citations: 11 total citations by 11 documents	
h-index: 2	View h-graph
Co-authors: 18	
Subject area: Engineering , Energy View More	

28 Documents | Cited by 11 documents | 18 co-authors

28 documents View in search results format

Sort on: Date Cited by

Export all | Add all to list | Set document alert | Set document feed

Document Title	Author(s)	Year	Conference/Journal	Citations
Possibilities and limitations of measuring the energy of direct solar radiation	Škuletić, S., Radulović, V., Stešević, I.	2013	International Conference on Power Engineering, Energy and Electrical Drives	0
Optimization and protective distance of surge protective devices in low-voltage AC circuits	Škuletić, S., Radulović, V.	2011	Proceedings of the Universities Power Engineering Conference	0
Influence of combination wave generator's current undershoot on overvoltage protective characteristics	Radulović, V., Skuletic, S.	2011	IEEE Transactions on Power Delivery	4
Analysis of surge protection performance in low-voltage AC systems with capacitive load	Škuletić, S., Radulović, V.	2010	Proceedings of the Universities Power Engineering Conference	0
Implementation of different methods for PTDF matrix calculation in flow-based coordinated auction	Vukasovic, M., Skuletic, S.	2007	POWERENG 2007 - International Conference on Power Engineering - Energy and Electrical Drives Proceedings	6
Possibility of computer application for calculations of switching overvoltages originated by capacitive current's tripping	Škuletić, S., Savić, M., Radulović, V.	2007	Proceedings of the Universities Power Engineering Conference	0
Contribution to calculation of switching overvoltages originated by line energizing in the networks with lumped parameters	Škuletić, S., Radulović, V.	2006	41st International Universities Power Engineering Conference, UPEC 2006, Conference Proceedings	1
Possibilities of computer application for design of lightning protection of high voltage substation	Škuletić, S., Herold, G., Weindl, C., Knezevic, Lj.	2006	41st International Universities Power Engineering Conference, UPEC 2006, Conference Proceedings	0
Probability of appearance of certain value of phase to ground overvoltage due to direct lightning stroke	Skuletic, S., Vucinic, A.	2006	Series on Energy and Power Systems	0
Reliability assessment of composite power systems	Skuletic, S., Balota, A.	2005	Canadian Conference on Electrical and Computer Engineering	0

## Author History

Publication range: 1982 - 2013

References: 90

## Source history:

Proceedings of the Universities Power Engineering Conference View documents  
 Canadian Conference on Electrical and Computer Engineering View documents  
 Proceedings of the 17th Annual Conference on Information Sciences and Systems. View documents  
 View More

Show Related Affiliations



[Show abstract](#) | [Related documents](#)

Possibility for fast and easy calculations and analysis of switching overvoltages	Skuletic, S., Radulovic, V.	2004	39th International Universities Power Engineering Conference, UPEC 2004 - Conference Proceedings	0
---	--------------------------------	------	--	---

[Show abstract](#) | [Related documents](#)

Simplification of the lightning limiting parameters method by establishing the equivalent flashover voltage characteristic	Skuletic, S.,Savic, M., Muratovic, D.	2004	39th International Universities Power Engineering Conference, UPEC 2004 - Conference Proceedings	0
--	--	------	--	---

[Show abstract](#) | [Related documents](#)

Experimental investigations of switching overvoltages in 110 kV network of power system of Montenegro	Skuletic, S.D., Mijajlovic, P.	2003	2003 IEEE Bologna PowerTech - Conference Proceedings	0
---	-----------------------------------	------	--	---

[Show abstract](#) | [Related documents](#)

Insulation flashover - Voltage probability distribution influence to the overhead line lightning performance estimation	Savic, M.,Skuletic, S., Muratovic, D.	2003	Proceedings of the Universities Power Engineering Conference	0
---	--	------	--	---

[Show abstract](#) | [Related documents](#)

Analysis of switching overvoltages originated by line energizing in simple and complex systems	Skuletic, S., Vujosevic, S.	2001	Proceedings of the Universities Power Engineering Conference	0
--	--------------------------------	------	--	---

[Show abstract](#) | [Related documents](#)

Analysis of switching overvoltages originated by line energizing in simple and complex systems	Skuletic, S., Vujosevic, S.	2001	Proceedings of the Universities Power Engineering Conference	0
--	--------------------------------	------	--	---

[Show abstract](#) | [Related documents](#)

Possibilities for an analysis of switching overvoltages due to three-phase faults tripping with a discrete method	Skuletic, S., Vujosevic, S.	2000	Proceedings of the Universities Power Engineering Conference	0
---	--------------------------------	------	--	---

[Show abstract](#)

Reliability analysis - a mean for improvement of power system characteristics	Skuletic, S., Allan, R.N.	1999	Proceedings of the Universities Power Engineering Conference	0
---	------------------------------	------	--	---

[Show abstract](#) | [Related documents](#)

Switching overvoltage measurements in distribution networks with circuit breaker controlled switching moments	Savic, M.S., Vujosevic, I., Rakocevic, Dj.,(...), Perovic, D., Perunicic, D.	1997	Proceedings of the Universities Power Engineering Conference	0
---	--	------	--	---

[Show abstract](#)

Approach for reliability modelling and evaluation of complex electric substations schemes	Skuletic, Sreten	1995	Modelling, Measurement and Control A	0
---	------------------	------	--------------------------------------	---

[Show abstract](#) | [Related documents](#)Display  results per page

Page 1

[Top of page](#)

The data displayed above is compiled exclusively from articles published in the Scopus database. To request corrections to any inaccuracies or provide any further feedback, please contact us (registration required). The data displayed above is subject to the privacy conditions contained in the [privacy policy](#).

[About Scopus](#)[What is Scopus](#)[Content coverage](#)[Scopus Blog](#)[Scopus API](#)[Language](#)

日本語に切り替える

切换到简体中文

切换到繁體中文

[Customer Service](#)[Help and Contact](#)

ELSEVIER

[Terms and Conditions](#)[Privacy policy](#)

Copyright © 2016 Elsevier B.V. All rights reserved. Scopus® is a registered trademark of Elsevier B.V.

Cookies are set by this site. To decline them or learn more, visit our [Cookies page](#)

RELX Group™





# UNIVERZITET CRNE GORE

81001 PODGORICA Cetinjski put bb, P. Fah 99, Jugoslavija  
Tel: (38 81) 14-484 Fax: (38 81) 11-301

BROJ: 01-820  
PODGORICA, 18.11. 1994.

04/2-968/a  
21 11 94

NA OSNOVU ČLANA 97. ZAKONA O UNIVERZITETU ("SL.LIST RCG" 37/92), ČLANA 18. ZAKONA O IZMJENAMA I DOPUNAMA ZAKONA O UNIVERZITETU, ("SL.LIST RCG" 6/94) I ČLANA 94. STATUTA UNIVERZITETA CRNE GORE, NAUČNO-NASTAVNO VIJEĆE UNIVERZITETA NA SJEDNICI ODRŽANOJ 30. 06. 1994. GODINE, DONIJELO JE

## O D L U K U

O POTVRDJIVANJU IZBORA Dr SRETENU ŠKULETIĆU

U ZVANJE REDOVNOG PROFESORA UNIVERZITETA CRNE GORE  
ZA PREDMETE Elektrane

ZA RAD NA NEODREDJENO VRIJEME SA PUNIM RADNIM VREMENOM NA  
Elektrotehničkom fakultetu u Podgorici.

PRAVNA POUKA: Protiv ove Odluke lica koja smatraju da su im povrijeđena prava imaju pravo žalbe Naučno-nastavnom vijeću Univerziteta Crne Gore u roku od 15 dana.

REKTOR  
*[Signature]*  
Prof. Dr. Božidar Nikolić

CV  
Isuf F. Krasnići

<b>OBRAZOVANJE</b>	
1987	Dr. Sc., Univerzitet u Prištini, Elektrotehnički Fakultet Teza: "Elektrostatički motor - Venac".
1978	Mr. Sc., Univerzitet u Zagrebu, Elektrotehnički Fakultet Teza: Oneciscenje izolatora na elektroenergetskim postrojenjima
1972	Diplomirani inženjer, Univerzitet u Prištini, Tehnički Fakultet Teza: "Prekidači visokog napona sa gasom SF6 "
<b>PROFESIONALNA KARIJERA I AKADEMSKI POZIVI</b>	
Od 2012	Redovan član Akademije Nauka i Umjetnosti Kosova.
Od 2009	Sekretar Akademije Nauka i Umjetnosti Kosova.
Od 2008	Član dopsinik Akademije Nauka i Umjetnosti Kosova.
Od 1998 do sada	Redovan Profesor, Elektrotehnički Fakultet, Univerzitet u Prištini
1993-1998	Vanredni Profesor, Elektrotehnički Fakultet, Univerzitet u Prištini
1987-1993	Docent, Elektrotehnički Fakultet, Univerzitet u Prištini.
1978-1987	Predavac, Elektrotehnički Fakultet, Univerzitet u Prištini.
1974-1978	Mladi asistent, Elektrotehnički Fakultet, Univerzitet u Prištini.
<b>POZICIJE U UNIVERZITETU</b>	
2009	Član državnog Saveta za Nauku Kosova
2008	Član Saveta za Doktorske Disertacije Univerziteta u Prištini
2007 – 2014	Šef odseka za Elektrohniku u Fakultetu za Električnu i Kompjutersku Inženjeriju, Univerzitet u Prištini.
2000-do sada	Član Saveta u Fakultetu za Električnu i Kompjutersku Inženjeriju, Univerzitet Priština.
1996-1999	Predsednik Centralnog Saveta za prosvetu republike Kosova
1988-1994	Dekan Elektrotehničkog Fakulteta, Univerzitet u Prištini
1980-1982	Zamenik Šefa Elektrotehničkog Fakulteta, Univerzitet u Prištini
<b>PREDMETI</b>	
2007– do sada	Tehnika visokog napona, Koordinacija izoacije i Elektrotehničke Materijale, Fakultet za Električnu i Kompjutersku Inženjeriju, Univerzitet u Prištini.
1987-2007	Tehnika visokog napona, Elektrotehničke Materijale, Elektrotehnički Fakultet, Univerzitet u Prištini.
1997-1999	Elektrotehničke Materijale, Fakultet za Električnu Inženjeriju, Univerzitet u Tetovo
1978-1980	Električne mašine, Visoka tehnička Škola, Mitrovica, Univerzitet u Prištini.
1973-1978	Laboratorske vežbe za predmete katedre za Električna Merenja, Tehnički Fakultet, Elektrotehnički Odsek, Univerzitet u Prištini.



## NAUČNI RADOVI

1.	I. Krasniqi "Prenos najvisim naponom", Elektrotehnicki Fakultet Zagreb, 1976
2.	I. Krasniqi "Uticaj korona na prenos radio i TV signala", <b>Elektrotehnički Fakultet Zagreb, 1976</b>
3.	I. Krasniqi "Oneciscenje izolatora na elektroenergetskim postrojenjima" <b>Magistarski rad, Elektrotehnički Fakultet Zagreb, 1978</b>
4.	I. Krasniqi "Klasicni i radioaktivni gromobran", Opatia 1979, Kroaci
5.	I. Krasniqi "Efekat indsutrijske zagadjenosti na EES TC KOSOVA B", <b>simpozium JUREM 1980</b>
6.	I. Krasniqi, A. Abazi, S. Limari "Efekat indsutrijske zagadjenosti na EES TC KOSOVA B", <i>casopis RMKK-KOSOVA</i> 1985
7.	I. Krasniqi, G. Latifi, "Odvodnici prenapona ZnO" <b>bilten Elektrotehničkog Fakulteta, 1985, Priština</b>
8.	I. Krasniqi 'Electrostatic Corona motor" <b>Third International Conference on electrostatics, Cracou, Poland, 1985</b>
9.	I. Krasniqi "Elektrostaticni motor-Venac", doktorski rad, Pristina, 1987
10.	I. Krasniqi, A. Abazi, "Utjecajugla elektroda na vrednosti ulaznih parametra motora Venac", Medjunarodni <b>Simpozijum za geoelektricitet i gromobran, Nis, 1988</b>
11.	I. Krasniqi, A. Abazi, "The influence bent Electrode Angle on the input and output of PVC electrostatics Corona Motor" <b>Fourth International Conference on Electrostatics, Wroclaw-Szklarska Poreba, Poland 1990</b>
12.	I. Krasniqi "Jedan poseban osvrt na 'krunu" kao pojam visokg napona" <i>Casopis DARDANIA SACRA</i> Nr. 4, Prishtinë, 2002
13.	I. Krasniqi, G. Kabashi "Zastita vodova visokog napona sa ZnO odvodnicima prenapona", <i>Istrazni casopis KERKIME - Akademia Nauka i Umetnosti Kosova, Priština, 2007</i>
14.	I. Krasniqi, V. Rexhepi, "Zastita transformatora 400kV sa ZnO odvodnicima prenapona", <i>Casopis KËRKIME- Akademije i Nauka Kosova, Priština, 2008</i>
15.	I. Krasniqi, A. Alidemaj "Efektet e Kurorës dhe roli i saj", : <i>Revista KËRKIME- Akademija i Nauka Kosova,, Priština, 2008.</i>
16.	I. Krasniqi, A. Alidemaj, "Efikasnost elektrostatičkih filtra u TC Kosova" B, objavljeno u <b>BTSH- Tirana, 2008,</b>
17.	I. Krasniqi, V. Rexhepi, "Zastita trafostanica 400 kV sa odvodnicima prenapona , <b>Albashkenca, Tiranë, septembar 2008.</b>
18.	I. Krasniqi, A. Alidemaj, "Efficiency of electrostatic precipitators at Kosova "B" BP, <b>Second International Conference, Balkan Power, Shibenik, september, 2008</b>
19.	I. Krasniqi, V. Rexhepi, "Protection of Energetic Transformers on the side 400kV from Overvoltage through Arresters Metal – Oxide, ZnO, and their Modeling", <b>Word Scientific and Engineering Academy and Society, Santander, Cantabria, Spain, September 2008.</b>
20.	I. Krasniqi, A. Perçuku " Synchronous Compensator to regulate Voltage Profile and increase Power System Security', <b>International Conference of Power and</b>



	<i>Energy, Houston, USA, April 2009</i>
21.	Isuf KRASNIQI and Arbër Përçuku: "Development Planning Transmission network 2010-2020 (Long term planning), <b>Bashkëpunimi Shqipëri Kosovë, Prishtinë 2010</b>
22.	I. KRASNIQI and A. KOKA : "POWER FLOW ANALYSIS: SIMULATION FOR DIFFERENT BUSES OF A SYSTEM, <b>Albshkenca, Tiranë, shtator 2010</b>
23.	I. Krasniqi, I. Kerolli, A. Lekaj ANALIZA GASOVA U ULJE TRANSFORMATORA - EFEKAT FUKO STRUJA Casopis <b>KERKIME</b> , Akademija i Nauka Kosova, <b>2010</b>
24.	V. komoni, I. Krasniqi, G. Kabashi, A. Alidemaj: "Increase Power Transfer Capability and Controlling Line Power Flow in Power System Installed the FACTS", <b>7th Mediterranean Conference and Exhibition on Power Generation, transmission, Distribution and Energy Conversion, 7-10 November 2010 , Agia Napa, Cyprus</b>
25.	Vehbi Sofiu <sup>1</sup> , Zamir Dika <sup>1</sup> , Isuf Krasniqi <sup>1</sup> , „IMPLEMENTATION OF SOLAR LED LIGHTING IN SHTIME“ <b>ANNUAL SESSION OF SCIENTIFIC PAPER "IMT ORADEA- 2011"</b> <b>Universitea Din Oradea, 26-28 May, 2011 Romania</b>
26.	B. Prebreza, I. Krasniqi, G. Kabashi, G. Pula, N. Avdiu „DISTURBANCES OF NORMAL OPERATION OF KOSOVA POWER SYSTEM REGARDING ATMOSPHERIC DISCHARGES“ <b>World Academy of Science, Engineering and Technology (WASET), 10th International Conference on Electric Machines and Drive Systems, Penang ,MALAYSIA, 22-24 February , 2011</b>
27.	I. Krasniqi, V. Komoni, A. Alidemaj, G. Kabashi „CORONA LOSSES DEPENDENCE FROM THE CONDUCTOR DIAMETER“ <b>World Academy of Science, Engineering and Technology (WASET), 11th. International Conference on Electric Power Systems, High Voltage, Electric Machines, Penang ,MALAYSIA, 3-5 October , 2011</b>
28.	I. Krasniqi, V. Komoni, A. Perçuku, S. Tahirsyla, „ANALIZA IMPLEMENTACIJE SOLARNIH PANELA “ <b>Buletini i punimeve shkencore KUD 621.3.004 Fakultet Električne Inžinjerie, Priština, decembar 2011</b>
29.	B. Prebreza, I. Krasniqi, G. Kabashi, K. Kadriu „INFLUENCE OF DIRECT AND INDIRECT LIGHTNING STROKES ON TRANSMISSION LINES OF THE KOSOVO POWER SYSTEM“ <b>Buletini i punimeve shkencore KUD 621.3.004 Fakultet Električne Inžinjerie, Priština, decembar 2011.</b>
<b>NAUČNO-PROFESIONALNI PROJEKTI</b>	
1.	“Strateski plan – urbani razvoj Prištine 2004-2020” u saradnji sa Nemačkim Institutima : Hesens Agentur, IWU, P4, Priština, 2004
2.	“Strateski razvojni plan Lipjana 2004-2015+” u saradnji sa Nemačkim Institutima : Hesens Agentur, IWU, P4, Priština, 2004
3.	“Strateski razvojni plan Djakovice 2006-2015+” u saradnji sa Nemačkim Institutima : Hesens Agentur, IWU, P4, Priština, 2008
4.	“Strateski razvojni plan Gnjilana 2006-2015+” u saradnji sa Nemačkim Institutima : Hesens Agentur, IWU, P4, Priština, 2008
5.	“Strateski razvojni plan Ferizaja 2006-2015+” u saradnji sa Nemačkim Institutima : Hesens Agentur, IWU, P4, Priština, 2008
6.	“Uticaj zagađenosti u sigurnost rada elektroenergetske opreme Kosova”



	Priština 1992, SIZ Nauka Kosova.
7.	“Zlatna plaketa” Izložba za inovacije, Split 1985
8.	“Patentiranje Motora Kruna” od Zavoda za patentiranje i plemenite metale, Beograd 1985.
9.	“Strateski razvojni plan Glogovca 2007-2015+” u saradnji sa Nemačkim Institutima : Hesenski Agentur, IWU, P4, Priština, 2008
10.	“Strateski razvojni plan Obilica 2008-2015+” u saradnji sa Nemačkim Institutima : Hesenski Agentur, IWU, P4, Priština, 2008
11.	“Strateski razvojni plan Vucitrna 2008-2015+” u saradnji sa nemačkim Institutima : Hesenski Agentur, IWU, P4, Priština, 2008
12.	Profili Urban i Planirani Regulusi “ <b>Priština e Re</b> ”- Priština 2008 u saradnji sa nemačkim Institutima: Hesenski Agentur, IWU, P4, Priština, 2008
<b>NAUČNE RECENZIJE</b>	
1.	“Analiza e prijenosnih karakteristika planarnih vodova u spektralnom domenu, od autora: A. Abazi, L.Ahmad, E. Hamiti, Akademije i Nauka Kosova, Priština 2000, časopis “KËRKIME”.
2.	“Upoređivanje prijenosnih karakteristika planarnih vodova na osnovu numeričke analize i gotovih relacija kao i ispitivanje konvergencije tih karakteristika”, od autora: A. Abazi, L.Ahmad, E. Hamiti, Akademije i Nauka Kosova, 2002, časopis “KËRKIME”
3.	“ Izračunavanje napona na pragu nmos tranzistora sa širokim kanalom (dugi) indukovanim kao i uticaj polarizovanog napona između sursa i donjeg sloja (tela)”, od autora: M. Limani, N. Caka dhe M. Zabeliza časopis “KËRKIME” Akademije i Nauka Kosova., Priština 2005.
4.	“Ispitivanje električnih uslova u Industrijsku zonu Kosova“ od autora R. Sefa, objavljivanje Akademije i Nauka Kosova, 2007, časopis “KËRKIME”
5.	“Elektromagnetni momenat kod motora sa različitim redoslijedom”, od autora N.Avdiju, B. Prebreza, objavljivanje od Akademije i Nauka Kosova, 2008, časopis “KËRKIME”
<b>PROFESIONALNI PROJEKTI</b>	
1.	“Termoelektrana Kosova B – Zgrada administrativno-tehnička služba”, glavni električni projekat, Elektroprivreda Kosova 1980, Priština
2.	“Termoelektrana Kosova B – Zgrada restorana društvene ishrane”, glavni električni projekat, Elektroprivreda Kosova, 1981, Priština
3.	Glavni projekat dalekovoda 20 kV i trafostanice za Opštinu Ferizaj, April 2000, financirano od USAID, USA.
4.	Glavni projekat kablovskog voda 20 kV i trafostanicu za Opštinu Gnjilane, Maj 2000, financirano od USAID, USA.
5.	Glavni projekat kablovskog voda 20 kV i trafostanicu za Opštinu Kamenicu, Maj 2000, financirano od USAID, USA.
6.	Glavni projekat električnih instalacija za Fabriku sokova u Ljipjane, 2001
7.	Izveštaj o elektroenergetskom stanju kompleksa zgrada Univerziteta u Prištini, Decembar 2000,
8.	Nadzor električnih radova za električne i elektronske instalacije u Autobuskoj Stanici u Prištini, 2000
9.	Nadzor električnih instalacija i gromobranske zaštite za zgradu Mašinskog Fakulteta, 2000, Priština



10.	Nadzor električnih instalacija i gromobranske zaštite, telefonske instalacije i signalizacije za zgradu Osnovnog Suda u Istog
11.	Nadzor električnih instalacija i gromobranske zaštite, telefonske instalacije i signalizacije za Zatvor u Istog, Januar 2000
12.	Nadzor električnih instalacija i uzemljenja Gradskog Stadiona Prištine, 2004.
13.	Profesionalni nadzor električnih instalacija i uređaja za trafostanicu 10(20) /0.4 kV, 1000 kVA, 630 kVA, kao i dalekovoda 20 kV u Aerodromu Prištine, 2002, 2003, Priština.
14.	Glavni projekat električnih instalacija Stambena zgrada naselje "MATI 1" Priština 2006.
15.	Profesionalni nadzor renoviranja trafostanice sa gasom SF6 110 /35/6,2 kV, Financirano od AER_a- Trepča - Mitrovica 2005-2006,
16.	Projektiranje i nadzor zgrade ProCredit Bank- Priština 2007-2008,
17.	Projektiranje i nadzor zgrade ProCredit Bank – Peč, 2008
<b>PROFESIONALNA ISPITIVANJA</b>	
1.	Ispitivanje i električnih instalacija i gromobrana u TE Kosova A- Obilić 1987
2.	Ispitivanje i električnih instalacija i gromobrana u TE Kosova B- Obilić 1988
3.	Ispitivanje i električnih instalacija i gromobrana trafostanice 110/35/6,3 kV- Mitrovica 2004
4.	Ispitivanje i električnih instalacija i gromobrana trafostanice 110/35/6,3 kV- Dečane 1989
5.	Ispitivanje i električnih instalacija i gromobrana Osnovne škole, Priština 2005
6.	Ispitivanje i električnih instalacija i gromobrana Fabrike Cevi sa klipovima, Dečane, 1989
7.	Ispitivanje i električnih instalacija i gromobrana zgrade Osnovnog Suda – Dečane 1989
8.	Ispitivanje i električnih instalacija i gromobrana u Fabrici Duvana- Gnjilane 1990
9.	Ispitivanje i električnih instalacija i gromobrana objekata Univerziteta u Prištini, 2000
10.	Ispitivanje električne opreme u Pumpnu stanicu Bivolak, vlasništvo "Ibar Lepeneac", Priština 2006
11.	Merenje i davanje protokola za otpornost zaštite svih dalekovoda 35 kV na vlasništvo Ibar-Lepeneac, Priština 2006
<b>DISPENSE I KNJIGE</b>	
1.	A.Abazi, J. Krasnići, "Elektrotehnički materijali" Fakultet Električne Inženjerije, Priština, 1982, Univerzitet u Prištini (Univerzitetni tekst)
2.	J. Krasnići, G. Latifi "Tehnika visokog napona" Fakultet Električne Inženjerije, Priština 1982, Univerzitet u Prištini.
3.	A.Abazi, J. Krasnići, S. Tahirsylaj "Elektrotehnički materijali", Knjiga za srednje škole, Priština 1985-1992
Član društva ili organizacija	
Od 1979	Društvo inženjera Kosova CIGRE- Kosovo
Od 1994	Institute of Electrical and Electronics Engineers (IEEE, USA)
Od 2007	Albaškenca- Tirana, Priština
2009-2011	Nacionalni Naučni Savet Kosova



MEDJUNARODNO ISKUSTVO I SARADNJA	
1974	Univerzitet u Sarajevu, Elektrotehnički Fakultet, Sarajevo, Bosnja i Hercegovina
1974-1978	Univerzitet u Zagrebu, Elektrotehnički Fakultet, Zagreb, Hrvatska
1978	Univerzitet u Tirani, Fakultet Električne Inženjerije, Albanija
1997	Univerzitet u Tetovo, Makedonija

JEZICI	
	Albanski – materni jezik
	Engleski
	Hrvatski-Bosanski-Crno Gorski-Srbski

Priština, Mart 2020

Akademik, Prof. Dr. Isuf Krasnići





PRISTINŠKI UNIVERZITET  
UNIVERSITAS STUDIORUM PRISHTINIENSIS

**ELEKTROTEHNIČKI FAKULTET I FAKULTET  
KOMPJUTERSVA**  
TEL + 381 38 554896, Fax: +381 38 542525  
Br. 11223/18 Priština, Dana 04.12.2018

Përkthet nga gjuha shqipe ne gjuhën serbe,kroate e anasjelltë  
Prevedo sa albanskog jezika na srpskom,hrvatskom jeziku i obratno  
Nr.Br 07 Date-Dana 04.12.2018 Prištine-Priština  
(Milaim Bislimi)

Usmenim zahtevom biv.asistenta Mr.Sc Avni Alidemaj i na osnovu podataka sa kojima raspolaže Elektrotehnički Fakultet i Fakultet Kompjutersva u Prištini, izdaje se ova:

### POTVRDA

Ovom se potvrđuje da na osnovu Odluke br. 122/98 od 27.03.1998 god, Prof. Dr. Isuf Krasniči, dobijo zvanje nastavnog naučnika, Ordinarni Profesor, dana 26.03.1998 god, za predmete: Elektrotehnički Materiali i Tehnika Visokog Napona u Elektrotehničkom Fakultetu u Prištini. Potvrda se izdaje na zahtev biv. njegovog asistenta Mr. Sc. Avni Alidemaj, i važi za regulisanje dokumentacije radi doktorske studije u inostranstvo, potvrda ne važi za druge svrhe.

DEKAN

Prof. Dr. Enver Hamiti

Potvrđeno ručnim potpisom

Pečat: Pristinški Univerzitet, Elektrotehnički Fakultet i Fakultet Kompjutersva







UNIVERSITETI I PRISHTINËS  
UNIVERSITAS STUDIORUM PRISHTINIENSIS

**FAKULTETI I INXHINIERISË ELEKTRIKE DHE  
KOMPJUTERIKE**

TEL + 381 38 554896, Fax: +381 38 542525

Nr. 11223/18 Prishtinë Me 04.12.2018

Me kërkesën verbale të ish asistentit Mr.sc. Avni Alidemaj dhe në bazë të shënimeve që posedon Fakulteti i Inxhinierisë Elektrike dhe Kompjuterike në Prishtinë, lëshohet ky :

## V È R T E T I M

Me këtë vërtetojmë se bazuar në Vendimin me nr.122/98 të datës 27.03.1998, Prof.dr.Isuf Krasniqi, ka marrë thirrjen shkencore mësimore profesor ordinar me dt.26.03.1998 për lëndët : **Materialet elektroteknike, dhe Teknika e tensioneve të larta** , në Fakultetin e Elektroteknikës në Prishtinë.

Vërtetimi lëshohet me kërkesën e ish asistentit të tij Mr.sc.Avni Alidemaj, dhe vlen për rregullimin e dokumentacionit për studimet e doktoratës jashtë vendit, vërtetimi nuk vlen për raste tjera .

DEKANI

Prof.Dr.Enver Hamiti





Prishtina 4 april 2018  
Ref. No. 467

The Kosova Academy of Sciences and Arts, on the basis of the available records, issues the following:

### CONFIRMATION

Herewith, we confirm that Professor Isuf Krasniqi is a regular member of the Kosova Academy of Sciences and Arts.

Lendita Pula  
Secretary of the Academy

